

## NPN Digital Transistors (Built-in Resistors)

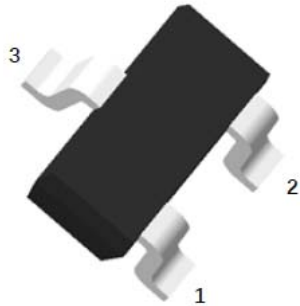

1: IN  
2: GND  
3: OUT

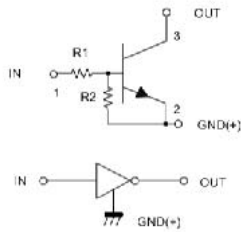

### Features

- Moisture sensitivity level 1
- Halogen free and RoHS compliant
- Surface mount package ideally suited for automatic insertion

### Application

- Signal amplification
- Switching circuit

### Mechanical data

- **Package:** SOT-523
- **Terminals:** Tin plated leads, solderable per J-STD-002 and JESD22-B102

### ■ Maximum Ratings (T<sub>a</sub>=25°C Unless otherwise specified)

Item	Symbol	Unit	Conditions	Value
Device marking code				24
Supply voltage	V <sub>CC</sub>	V		50
Input voltage	V <sub>IN</sub>	V		-10 to +40
Output current	I <sub>O</sub>	mA		100
Power dissipation	P <sub>D</sub>	mW		150
Operation junction temperature	T <sub>J</sub>	°C		-55 to +150
Storage temperature	T <sub>STG</sub>	°C		-55 to +150



# DTC114EE

RoHS  
COMPLIANT

## ■ Electrical Characteristics (T<sub>a</sub>=25°C Unless otherwise specified)

Item	Symbol	Unit	Conditions	Min	Typ	Max
Input voltage	V <sub>I(off)</sub>	V	V <sub>CC</sub> =5V, I <sub>o</sub> =100μA	0.5		
Collector-emitter breakdown voltage	V <sub>I(on)</sub>	V	V <sub>o</sub> =0.3V, I <sub>o</sub> =10mA			3
Output voltage	V <sub>O(on)</sub>	V	I <sub>o</sub> /I <sub>i</sub> =10mA/0.5 mA			0.3
Input current	I <sub>i</sub>	mA	V <sub>i</sub> =5V			0.88
Output current	I <sub>O(off)</sub>	μA	V <sub>CC</sub> =50V, V <sub>i</sub> =0			0.5
DC current gain	G <sub>1</sub>		V <sub>o</sub> =5V, I <sub>o</sub> =5mA	30		
Input resistance	R <sub>1</sub>	kΩ		7	10	13
Resistance ratio	R <sub>2</sub> /R <sub>1</sub>			0.8	1	1.2
Transition frequency	f <sub>T</sub>	MHz	V <sub>o</sub> =10V, I <sub>o</sub> =5mA		250	

## ■ Thermal Characteristics

Parameter	Symbol	Unit	Value
Thermal resistance, junction-to-ambient	R <sub>θJ-A</sub> <sup>(1)</sup>	°C/W	833
Thermal resistance, junction-to-case	R <sub>θJ-C</sub> <sup>(1)</sup>	°C/W	666

### Note:

(1) Thermal resistance from junction to ambient and from junction to case mounted on P.C.B. with 25.4mm\*25.4mm copper pad areas



■ Characteristics

Fig 1: ON Characteristics

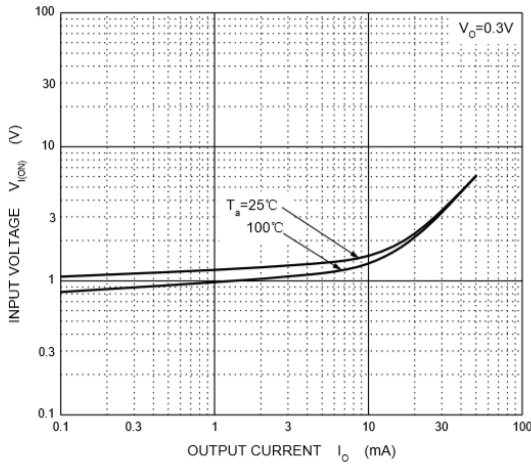

Fig 2: OFF Characteristics

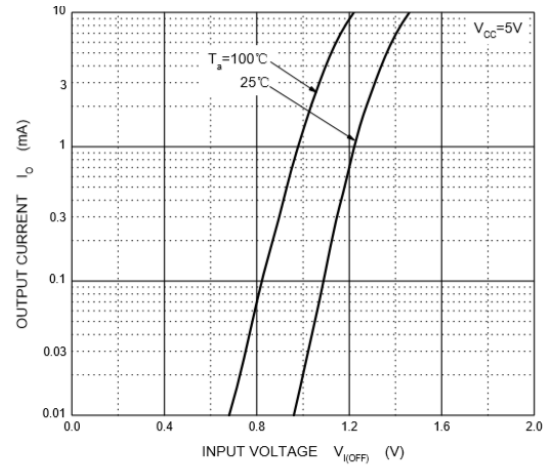

Fig 3:  $V_{O(ON)} - I_o$

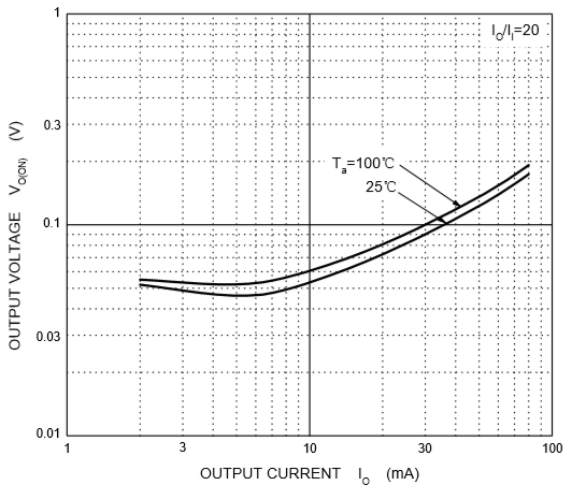

Fig 4:  $G_i - I_o$

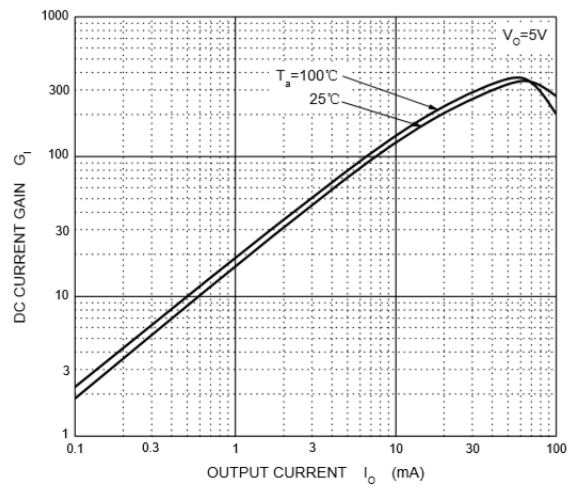
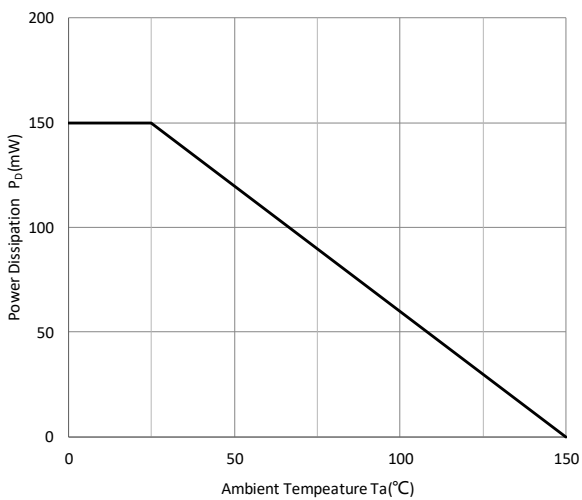

Fig 5:  $P_D - T_a$  Curve





# DTC114EE

RoHS  
COMPLIANT

## Ordering Information

Preferred P/N	Packing code	Unit weight(g)	Minimum package(pcs)	Inner box quantity(pcs)	Outer carton quantity(pcs)	Delivery mode
DTC114EE	F2	Approximate 0.0027	3000	30000	120000	7" reel

## Outline Dimensions

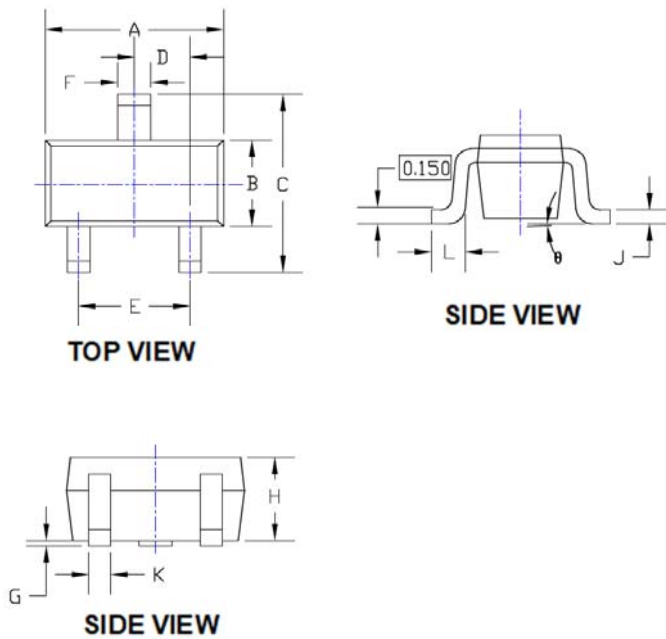

SYMBOL	DIMENSIONS			
	INCHES		Millimeter	
	MIN.	MAX.	MIN.	MAX.
A	0.059	0.067	1.500	1.700
B	0.030	0.033	0.750	0.850
C	0.057	0.069	1.450	1.750
D	0.020TYP		0.500TYP	
E	0.035	0.043	0.900	1.100
F	0.010	0.018	0.250	0.450
G	0.000	0.004	0.000	0.100
H	0.024	0.031	0.600	0.800
J	0.004	0.008	0.100	0.200
K	0.006	0.014	0.150	0.350
L	0.010	0.018	0.260	0.460
θ	0°	8°	0°	8°

## Suggested Pad Layout

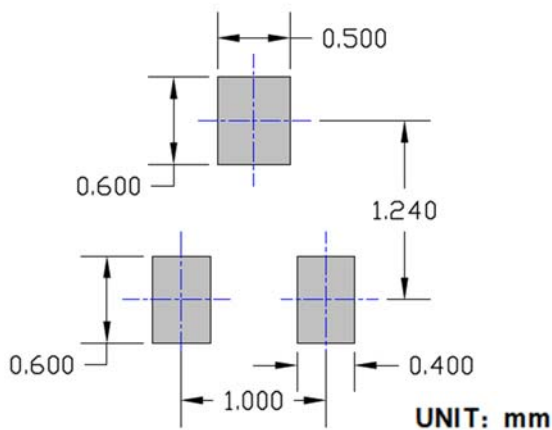



---

**Disclaimer**

The information presented in this document is for reference only. Yangzhou Yangjie Electronic Technology Co., Ltd. reserves the right to make changes without notice for the specification of the products displayed herein to improve reliability, function, or design or otherwise.

The product listed herein is designed to be used with ordinary electronic equipment or devices, and not designed to be used with equipment or devices which require high level of reliability and the malfunction of which would directly endanger human life (such as medical instruments, transportation equipment, aerospace machinery, nuclear-reactor controllers, fuel controllers and other safety devices), Yangjie or anyone on its behalf, assumes no responsibility or liability for any damages resulting from such improper use of sale.

This publication supersedes & replaces all information previously supplied. For additional information, please visit our website [http:// www.21yangjie.com](http://www.21yangjie.com) , or consult your nearest Yangjie's sales office for further assistance.