

PNP General Purpose Amplifier

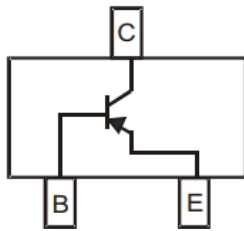

SOT-23

Features

- Epoxy meets UL-94 V-0 flammability rating and halogen free
- Moisture Sensitivity Level 1
- High Conductance
- Part no. with suffix "Q" means AEC-Q101 qualified

Applications

- Switching and linear amplification

Mechanical Data

- **Case:** SOT-23
- **Terminals:** Tin plated leads, solderable per J-STD-002 and JESD22-B102
- **Marking:** 2F

■ Maximum Ratings (Ta=25°C unless otherwise noted)

Item	Symbol	Unit	Value
Collector-Base Voltage	V_{CBO}	V	-60
Collector-Emitter Voltage	V_{CEO}	V	-60
Emitter-Base Voltage	V_{EBO}	V	-5
Collector Current -Continuous	I_C	mA	-600
Total Device Dissipation (*)	P_D	mW	300
Thermal Resistance Junction to Ambient (*)	R_{thJA}	K/W	417
Junction Temperature	T_J	°C	-55 to +150
Storage Temperature	T_{STG}	°C	-55 to +150

(*) Device mounted on FR-4 PCB 1.0 x 1.0 x 0.06 inch



■ Electrical Characteristics (Ta=25°C unless otherwise noted)

Item	Symbol	Unit	Conditions	Min	Max
Collector-emitter breakdown voltage	$V_{(BR)CEO}$	V	$I_C = -10mA, I_B = 0$	-60	
Collector-base breakdown voltage	$V_{(BR)CBO}$	V	$I_C = -10\mu A, I_E = 0$	-60	
Emitter-base breakdown voltage	$V_{(BR)EBO}$	V	$I_E = -10\mu A, I_C = 0$	-5	
Collector cut-off current	I_{CEX}	nA	$V_{CE} = -30V, V_{EB} = -0.5V$		-50
Collector cut-off current	I_{CBO}	nA	$V_{CB} = -50V, I_E = 0$		-20
DC current gain	h_{FE}		$V_{CE} = -10V, I_C = -0.1mA$	75	
	h_{FE}		$V_{CE} = -10V, I_C = -1mA$	100	
	h_{FE}		$V_{CE} = -10V, I_C = -10mA$	100	
	h_{FE}		$V_{CE} = -10V, I_C = -150mA$	100	300
	h_{FE}		$V_{CE} = -10V, I_C = -500mA$	50	
Collector-emitter saturation voltage	$V_{CE(sat)}$	V	$I_C = -150mA, I_B = -15mA$		-0.4
			$I_C = -500mA, I_B = -50mA$		-1.6
Base-emitter saturation voltage	$V_{BE(sat)}$	V	$I_C = -150mA, I_B = -15mA$		-1.3
			$I_C = -500mA, I_B = -50mA$		-2.6
Transition frequency	f_T	MHz	$V_{CE} = -20V, I_C = -50mA, f = 100MHz$	200	
Turn-on time	t_{on}	ns	$V_{CC} = -30V, I_C = -150mA, I_{B1} = -15mA$		45
Delay time	t_d	ns			10
Rise time	t_r	ns			40
Turn-off time	t_{off}	ns	$V_{CC} = -30V, I_C = -150mA, I_{B1} = I_{B2} = -15mA$		270
Storage time	t_s	ns			225
Fall time	t_f	ns			60

■ Ordering Information (Example)

PREFERED P/N	PACKING CODE	UNIT WEIGHT(g)	MINIMUM PACKAGE(pcs)	INNER BOX QUANTITY(pcs)	OUTER CARTON QUANTITY(pcs)	DELIVERY MODE
MMBT2907AQ	F2	Approximate 0.01	3000	30000	120000	7" reel



■ Characteristics (Typical)

Fig.1 - Static characteristic

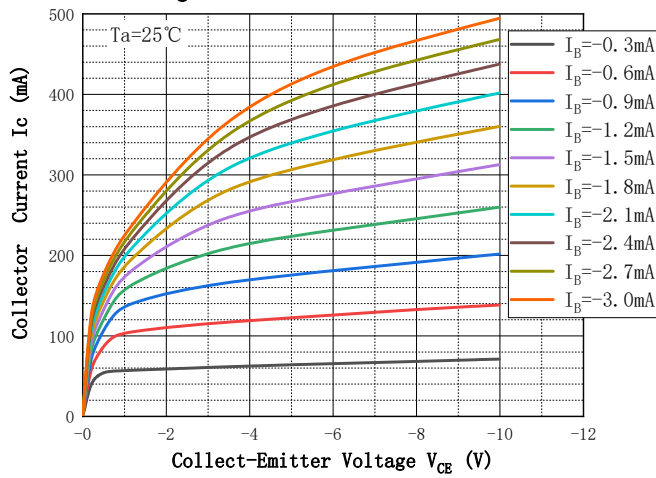

Fig.2 - DC Current Gain

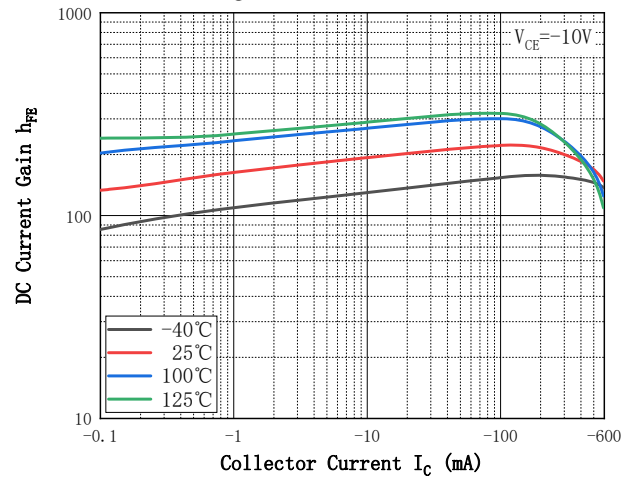

Fig.3 - Collect-Emmitter Saturation Voltage

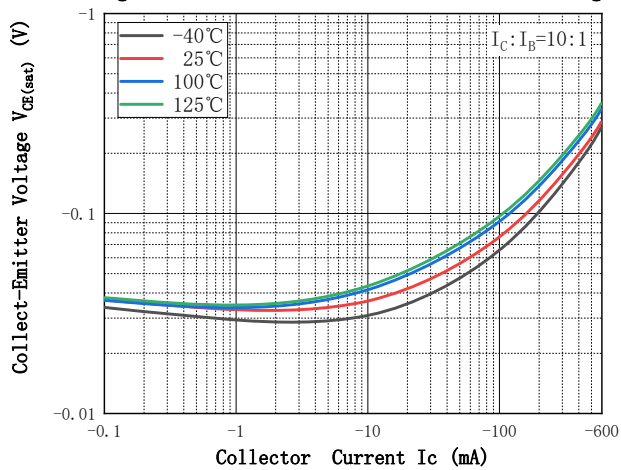

Fig.4 - Base-Emmitter Voltage

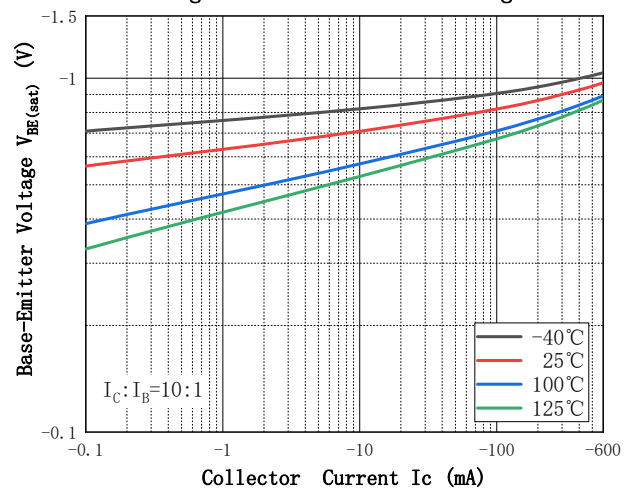

Fig.5 - Base-Emmitter On Voltage

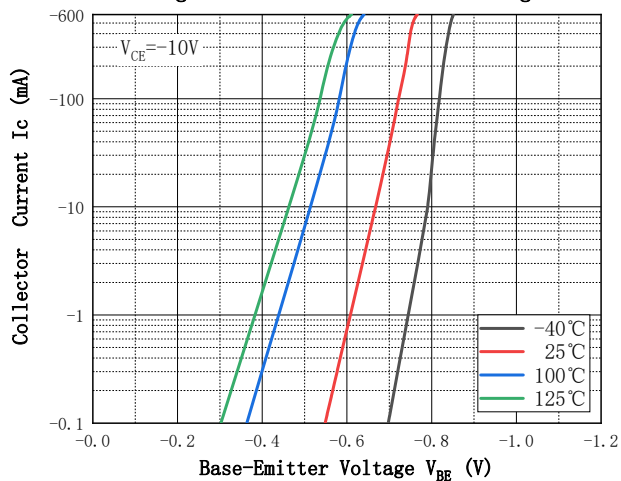
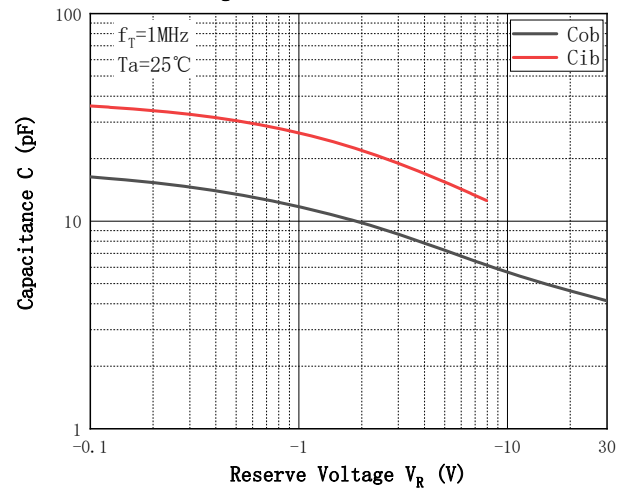
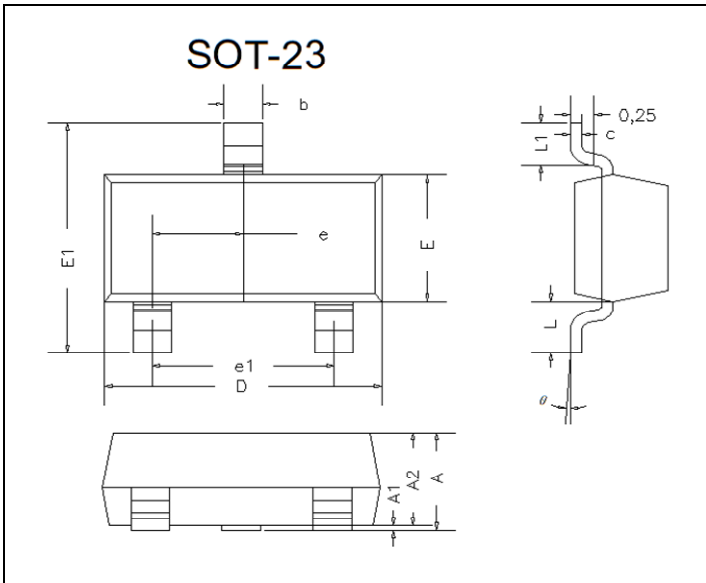

Fig.6 - Cob/Cib—VCB/VEB



■ SOT-23 Package Outline Dimensions



DIM	INCHES		MM		NOTE
	MIN	MAX	MIN	MAX	
A	0.035	0.045	0.90	1.15	
A1	0.000	0.004	0.00	0.10	
A2	0.035	0.041	0.90	1.05	
b	0.012	0.020	0.30	0.50	
c	0.004	0.008	0.10	0.20	
D	0.110	0.118	2.80	3.00	
E	0.047	0.055	1.20	1.40	
E1	0.089	0.100	2.25	2.55	
e	0.370TYP		0.95TYP		
e1	0.071	0.079	1.80	2.00	
L	0.220REF		0.55REF		
L1	0.012	0.020	0.30	0.50	
θ	0°	8°	0°	8°	

■ SOT-23 Suggested Pad Layout

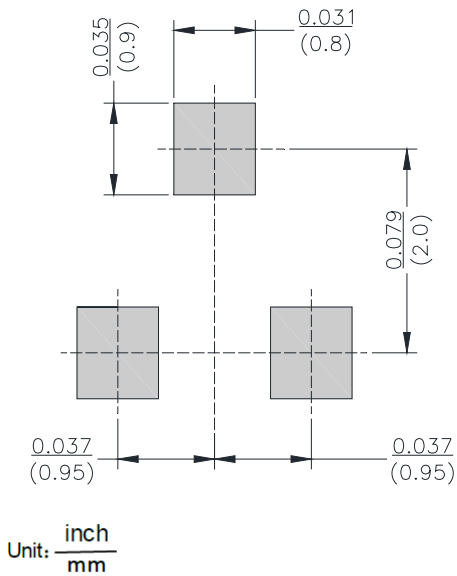



Disclaimer

The information presented in this document is for reference only. Yangzhou Yangjie Electronic Technology Co., Ltd. reserves the right to make changes without notice for the specification of the products displayed herein to improve reliability, function or design or otherwise.

The product listed herein is designed to be used with automotive electronics, are not designed for use in medical, life-saving, life-sustaining, or military. Yangjie or anyone on its behalf, assumes no responsibility or liability for any damages resulting from such improper use of sale.

This publication supersedes & replaces all information previously supplied. For additional information, please visit our website [http:// www.21yangjie.com](http://www.21yangjie.com) , or consult your nearest Yangjie's sales office for further assistance.