

N-Channel Enhancement Mode Field Effect Transistor

Product Summary

- V_{DS} 60V
- I_D 340mA
- $R_{DS(ON)}$ (at $V_{GS}=10V$) <2.5ohm
- $R_{DS(ON)}$ (at $V_{GS}=4.5V$) <3.0ohm

General Description

- Trench Power MV MOSFET technology
- Voltage controlled small signal switch
- Low input Capacitance
- Fast Switching Speed
- Low Input / Output Leakage

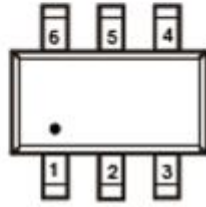
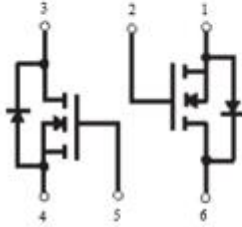

Dot denotes Pin1

SOT-363

Applications

- Battery operated systems
- Solid-state relays
- Direct logic-level interface: TTL/CMOS

■ Absolute Maximum Ratings ($T_A=25^\circ\text{C}$ unless otherwise noted)

Parameter	Symbol	Limit	Unit
Drain-source Voltage	V_{DS}	60	V
Gate-source Voltage	V_{GS}	± 30	V
Drain Current	I_D	$T_A=25^\circ\text{C}$ @ Steady State	340
		$T_A=70^\circ\text{C}$ @ Steady State	272
Pulsed Drain Current ^A	I_{DM}	1.5	A
Total Power Dissipation @ $T_A=25^\circ\text{C}$	P_D	150	mW
Thermal Resistance Junction-to-Ambient @ Steady State ^B	$R_{\theta JA}$	833	$^\circ\text{C}/\text{W}$
Junction and Storage Temperature Range	T_J, T_{STG}	-55~+150	$^\circ\text{C}$

■ Ordering Information (Example)

PREFERRED P/N	PACKING CODE	Marking	MINIMUM PACKAGE(pcs)	INNER BOX QUANTITY(pcs)	OUTER CARTON QUANTITY(pcs)	DELIVERY MODE
2N7002DW	F2	K72	3000	30000	120000	7" reel



2N7002DW

RECOMMEND
2N7002BDW
FOR NEW DESIGN

■ Electrical Characteristics (T_J=25°C unless otherwise noted)

Parameter	Symbol	Conditions	Min	Typ	Max	Units
Static Parameter						
Drain-Source Breakdown Voltage	BV _{DSS}	V _{GS} = 0V, I _D =250μA	60			V
Zero Gate Voltage Drain Current	I _{DSS}	V _{DS} =60V, V _{GS} =0V			1	μA
Gate-Body Leakage Current	I _{GSS1}	V _{GS} = ±30V, V _{DS} =0V			±100	nA
	I _{GSS2}	V _{GS} = ±20V, V _{DS} =0V			±50	nA
Gate Threshold Voltage	V _{GS(th)}	V _{DS} = V _{GS} , I _D =250μA	1	1.6	2.5	V
Static Drain-Source On-Resistance	R _{DS(on)}	V _{GS} = 10V, I _D =300mA		1.2	2.5	Ω
		V _{GS} = 4.5V, I _D =200mA		1.3	3.0	
Forward Transconductance	g _{fs}	V _{DS} =10 V, I _D =200mA	80			ms
Diode Forward Voltage	V _{SD}	I _S =300mA, V _{GS} =0V			1.2	V
Maximum Body-Diode Continuous Current	I _S				340	mA
Dynamic Parameters						
Input Capacitance	C _{iss}	V _{DS} =30V, V _{GS} =0V, f=1MHZ		27.5		pF
Output Capacitance	C _{oss}			2.75		
Reverse Transfer Capacitance	C _{rss}			1.9		
Switching Parameters						
Total Gate Charge	Q _g	V _{GS} =10V, V _{DS} =30V, I _D =0.3A		1.6		nC
Gate-Source Charge	Q _{gs}			0.47		
Gate-Drain Charge	Q _{gd}			0.25		
Reverse Recovery Charge	Q _{rr}	I _F =0.3A, di/dt=-100A/us		2.5		
Reverse Recovery Time	t _{rr}			11.5		
Turn-on Delay Time	t _{D(on)}	V _{GS} =10V, V _{DD} =30V, I _D =300mA, R _{GEN} =6Ω		3.3		ns
Turn-on Rise Time	t _r			19		
Turn-off Delay Time	t _{D(off)}			9.6		
Turn-off fall Time	t _f			49		

A. Pulse Test: Pulse Width ≤ 300us, Duty cycle ≤ 2%.

B. Device mounted on FR-4 PCB, 1 inch x 0.85 inch x 0.062 inch.



■ Typical Performance Characteristics

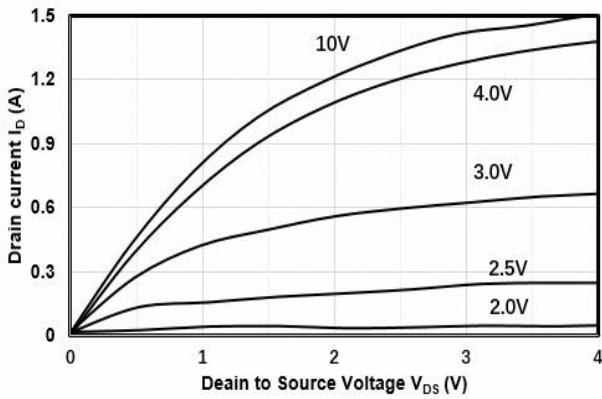

Figure1. Output Characteristics

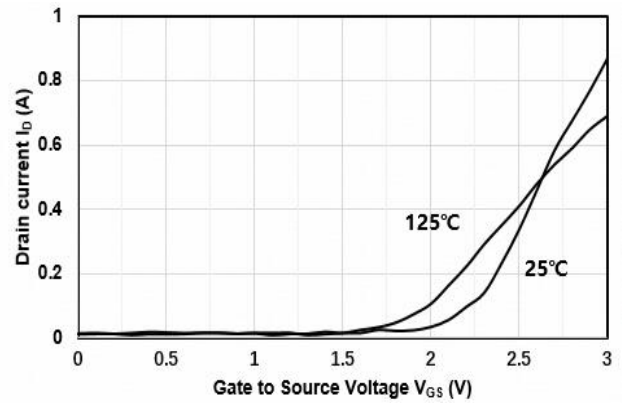

Figure2. Transfer Characteristics

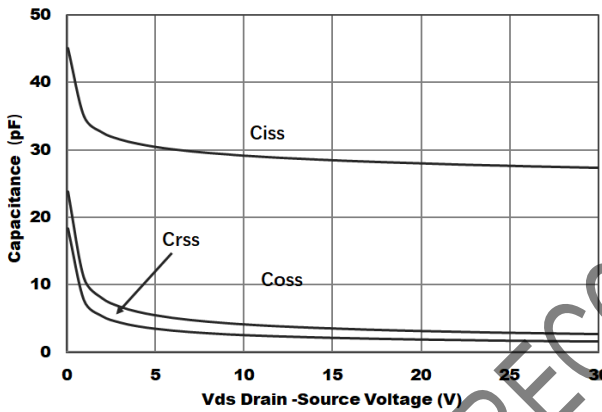

Figure3. Capacitance Characteristics

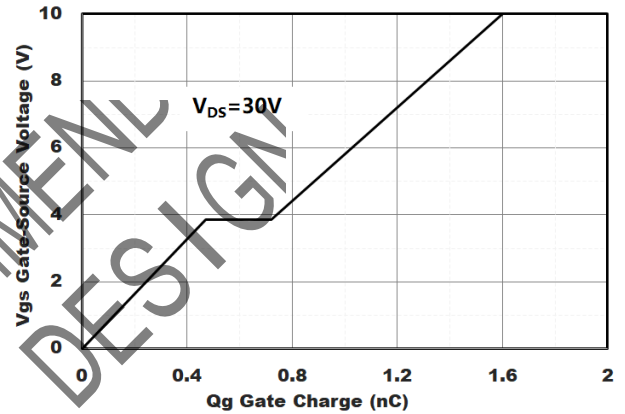

Figure4. Gate Charge

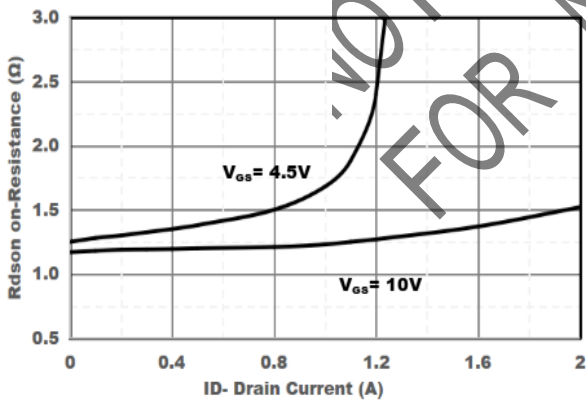

Figure5. Drain-Source on Resistance

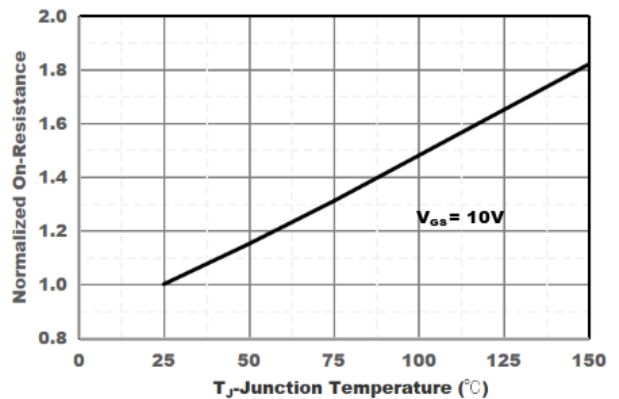

Figure6. Drain-Source on Resistance

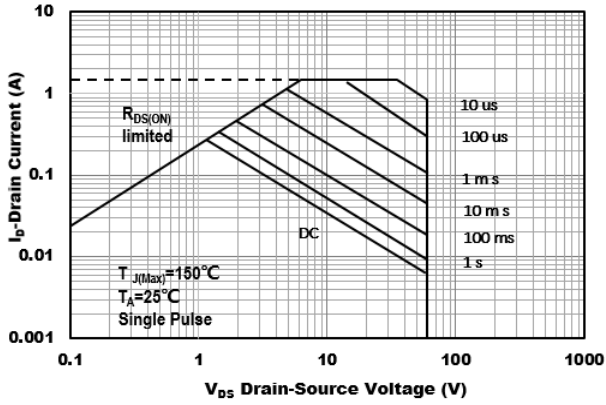

Figure7. Safe Operation Area

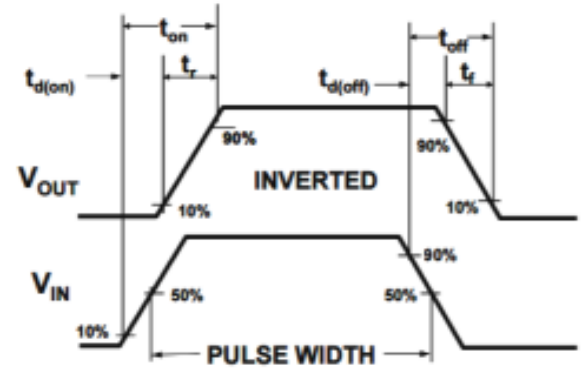
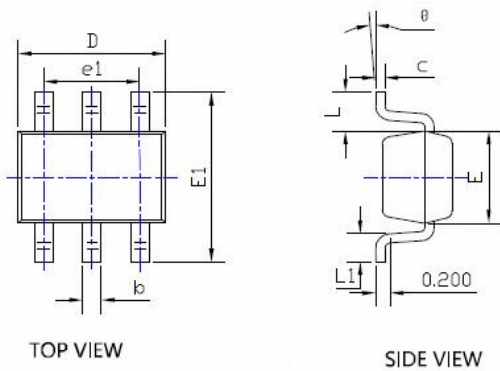

Figure8. Switching wave

NOT RECOMMEND
FOR NEW DESIGN

■ SOT-363 Package information



TOP VIEW

SIDE VIEW

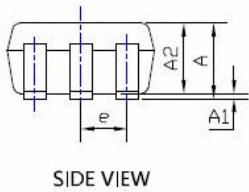

SIDE VIEW

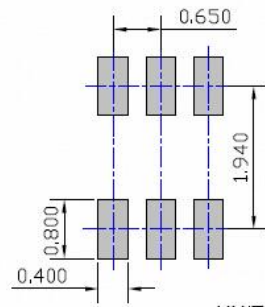

UNIT: mm

SUGGESTED SOLDER PAD LAYOUT

SYMBOL	DIMENSIONS					
	INCHES			Millimeter		
	MIN.	NOM.	MAX.	MIN.	NOM.	MAX.
A	0.035	---	0.043	0.900	---	1.100
A1	0.000	---	0.004	0.000	---	0.100
A2	0.035	0.037	0.039	0.900	0.950	1.000
b	0.006	0.010	0.014	0.150	0.250	0.350
c	0.004	---	0.010	0.100	---	0.250
D	0.071	0.079	0.087	1.800	2.000	2.200
E	0.045	0.049	0.053	1.150	1.250	1.350
E1	0.085	0.091	0.096	2.150	2.300	2.450
e	0.026TYP			0.650TYP		
e1	0.047	0.051	0.055	1.200	1.300	1.400
L	0.021REF			0.525REF		
L1	0.010	0.014	0.018	0.260	0.360	0.460
ø	0*	---	8*	0*	---	8*

NOTE:

1. PACKAGE BODY SIZES EXCLUDE MOLD FLASH AND GATE BURRS,
2. TOLERANCE 0.1mm UNLESS OTHERWISE SPECIFIED.
3. THE PAD LAYOUT IS FOR REFERENCE PURPOSES ONLY.

NOT RECOMMENDED FOR NEW DESIGN



Disclaimer

The information presented in this document is for reference only. Yangzhou Yangjie Electronic Technology Co., Ltd. reserves the right to make changes without notice for the specification of the products displayed herein to improve reliability, function or design or otherwise.

The product listed herein is designed to be used with ordinary electronic equipment or devices, and not designed to be used with equipment or devices which require high level of reliability and the malfunction of which would directly endanger human life (such as medical instruments, transportation equipment, aerospace machinery, nuclear-reactor controllers, fuel controllers and other safety devices), Yangjie or anyone on its behalf, assumes no responsibility or liability for any damages resulting from such improper use of sale.

This publication supersedes & replaces all information previously supplied. For additional information, please visit our website [http:// www.21yangjie.com](http://www.21yangjie.com) , or consult your nearest Yangjie's sales office for further assistance.

NOT RECOMMENDED
FOR NEW DESIGN