

## IGBT Modules

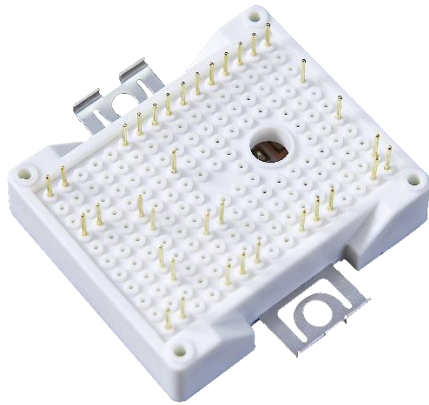

$V_{CES}$	1200V
$I_c$	35A

### Applications

- Motor Drivers
- AC and DC Servo Drive Amplifier
- UPS (Uninterruptible Power Supplies)

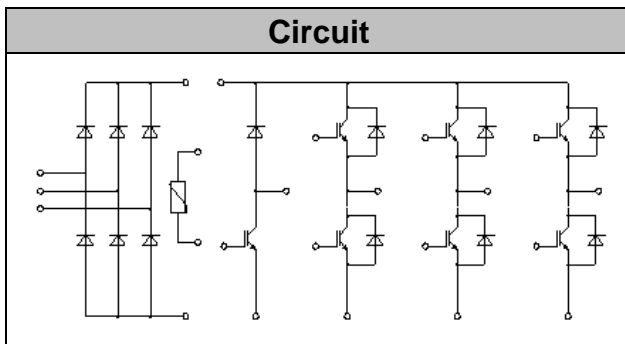

### Features

- Low switching losses
- Low  $V_{CE(sat)}$  with positive temperature coefficient
- Including fast & soft recovery anti-parallel FWD
- Low inductance case
- High short circuit capability(10us)
- Isolated heatsink using DBC technology
- Maximum junction temperature 175°C

## ● IGBT- inverter

### Absolute Maximum Ratings

Parameter	Symbol	Conditions	Value	Unit
Collector-Emitter Voltage	$V_{CES}$	$V_{GE}=0V, I_c=1mA, T_{vj}=25^{\circ}C$	1200	V
Continuous Collector Current	$I_c$	$T_c=100^{\circ}C, T_{vjmax}=175^{\circ}C$	35	A
Repetitive Peak Collector Current	$I_{CRM}$	$t_p=1ms$	70	A
Gate-Emitter Voltage	$V_{GES}$	$T_{vj}=25^{\circ}C$	$\pm 20$	V
Total Power Dissipation	$P_{tot}$	$T_c=25^{\circ}C, T_{vjmax}=175^{\circ}C$	210	W



## ● IGBT- inverter

### Characteristic Values

Parameter	Symbol	Conditions	Value			Unit	
			Min.	Typ.	Max.		
Gate-Emitter Threshold Voltage	$V_{GE(th)}$	$V_{GE}=V_{CE}, I_C=1.4mA, T_{vj}=25^{\circ}C$	5.2	5.8	6.4	V	
Collector-Emitter Cut-off Current	$I_{CES}$	$V_{CE}=1200V, V_{GE}=0V, T_{vj}=25^{\circ}C$			1.0	mA	
Collector-Emitter Saturation Voltage	$V_{CE(sat)}$	$I_C=35A, V_{GE}=15V, T_{vj}=25^{\circ}C$		1.82	2.50	V	
		$I_C=35A, V_{GE}=15V, T_{vj}=125^{\circ}C$		2.00			
		$I_C=35A, V_{GE}=15V, T_{vj}=150^{\circ}C$		2.10			
Gate Charge	$Q_G$			0.27		uC	
Input Capacitance	$C_{ies}$	$V_{CE}=25V, V_{GE}=0V,$ $f=1MHz, T_{vj}=25^{\circ}C$		2.5		nF	
Reverse Transfer Capacitance	$C_{res}$			0.087		nF	
Gate-Emitter leakage current	$I_{GES}$	$V_{CE}=0V, V_{GE}=20V, T_{vj}=25^{\circ}C$			400	nA	
Turn-on Delay Time	$t_{d(on)}$	$I_C=35A$ $V_{CE}=600V$ $V_{GE}=\pm 15V$ $R_G=20\Omega$ $T_{vj}=25^{\circ}C$		20		ns	
Rise Time	$t_r$			42		ns	
Turn-off Delay Time	$t_{d(off)}$			141		ns	
Fall Time	$t_f$			250		ns	
Energy Dissipation During Turn-on Time	$E_{on}$			4.45		mJ	
Energy Dissipation During Turn-off Time	$E_{off}$			1.95		mJ	
Turn-on Delay Time	$t_{d(on)}$		$I_C=35A$ $V_{CE}=600V$ $V_{GE}=\pm 15V$ $R_G=20\Omega$ $T_{vj}=150^{\circ}C$		18		ns
Rise Time	$t_r$				46		ns
Turn-off Delay Time	$t_{d(off)}$				155		ns
Fall Time	$t_f$				275		ns
Energy Dissipation During Turn-on Time	$E_{on}$			5.28		mJ	
Energy Dissipation During Turn-off Time	$E_{off}$			2.27		mJ	
SC Data	$I_{SC}$	$t_p \leq 10\mu s, V_{GE}=15V, T_{vj}=150^{\circ}C,$ $V_{CC}=900V, V_{CEM} \leq 1200V$			140		A



## ● Diode-inverter

### Absolute Maximum Ratings

Parameter	Symbol	Conditions	Value	Unit
Repetitive Peak Reverse Voltage	$V_{RRM}$	$T_{vj}=25^{\circ}C$	1200	V
Continuous DC Forward Current	$I_F$		35	A
Repetitive Peak Forward Current	$I_{FRM}$	$t_p=1ms$	70	A
$I^2t$ -value	$I^2t$	$V_R=0V, t_p=10ms, T_{vj}=125^{\circ}C$	240	A <sup>2</sup> s
		$V_R=0V, t_p=10ms, T_{vj}=150^{\circ}C$	220	

### Characteristic Values

Parameter	Symbol	Conditions	Value			Unit
			Min.	Typ.	Max.	
Forward Voltage	$V_F$	$I_F=35A, T_{vj}=25^{\circ}C$		2.10	2.80	V
		$I_F=35A, T_{vj}=125^{\circ}C$		1.95		
		$I_F=35A, T_{vj}=150^{\circ}C$		1.85		
Recovered Charge	$Q_{rr}$	$I_F=35A$		0.85		uC
Peak Reverse Recovery Current	$I_{rr}$	$V_R=600V$ $-di_F/dt = 900A/us$		23		A
Reverse Recovery Energy	$E_{rec}$	$T_{vj}=25^{\circ}C$		0.95		mJ
Recovered Charge	$Q_{rr}$	$I_F=35A$		4.75		uC
Peak Reverse Recovery Current	$I_{rr}$	$V_R=600V$ $-di_F/dt = 900A/us$		25		A
Reverse Recovery Energy	$E_{rec}$	$T_{vj}=125^{\circ}C$		1.66		mJ



**● IGBT-brake-chopper**  
**Absolute Maximum Ratings**

Parameter	Symbol	Conditions	Value	Unit
Collector-Emitter Voltage	$V_{CES}$	$V_{GE}=0V, I_C=1mA, T_{vj}=25^{\circ}C$	1200	V
Continuous Collector Current	$I_C$	$T_C=100^{\circ}C, T_{vjmax}=175^{\circ}C$	35	A
Repetitive Peak Collector Current	$I_{CRM}$	$t_p=1ms$	70	A
Gate-Emitter Voltage	$V_{GES}$	$T_{vj}=25^{\circ}C$	$\pm 20$	V
Total Power Dissipation	$P_{tot}$	$T_C=25^{\circ}C, T_{vjmax}=175^{\circ}C$	210	W

**Characteristic Values**

Parameter	Symbol	Conditions	Value			Unit
			Min.	Typ.	Max.	
Gate-emitter Threshold Voltage	$V_{GE(th)}$	$V_{GE}=V_{CE}, I_C=1.4mA, T_{vj}=25^{\circ}C$	5.2	5.8	6.4	V
Collector-Emitter Cut-off Current	$I_{CES}$	$V_{CE}=1200V, V_{GE}=0V, T_{vj}=25^{\circ}C$			1.0	mA
Collector-Emitter Saturation Voltage	$V_{CE(sat)}$	$I_C=35A, V_{GE}=15V, T_{vj}=25^{\circ}C$		1.82	2.50	V
		$I_C=35A, V_{GE}=15V, T_{vj}=125^{\circ}C$		2.00		
		$I_C=35A, V_{GE}=15V, T_{vj}=150^{\circ}C$		2.10		
Gate Charge	$Q_G$			0.27		uC
Input Capacitance	$C_{ies}$	$V_{CE}=25V, V_{GE}=0V, f=1MHz, T_{vj}=25^{\circ}C$		2.5		nF
Reverse Transfer Capacitance	$C_{res}$			0.087		nF
Gate-Emitter leakage current	$I_{GES}$	$V_{CE}=0V, V_{GE}=20V, T_{vj}=25^{\circ}C$			400	nA
Turn-on Delay Time	$t_{d(on)}$	$I_C=35A, V_{CE}=600V, V_{GE}=\pm 15V, R_G=20\Omega, T_{vj}=25^{\circ}C$		20		ns
Rise Time	$t_r$			42		ns
Turn-off Delay Time	$t_{d(off)}$			141		ns
Fall Time	$t_f$			250		ns
Energy Dissipation During Turn-on Time	$E_{on}$			4.45		mJ
Energy Dissipation During Turn-off Time	$E_{off}$			1.95		mJ



Turn-on Delay Time	$t_{d(on)}$	$I_C=35A$ $V_{CE}=600V$ $V_{GE}=\pm 15V$ $R_G=20\Omega$ $T_{vj}=150^\circ C$		18		ns
Rise Time	$t_r$		46		ns	
Turn-off Delay Time	$t_{d(off)}$		155		ns	
Fall Time	$t_f$		275		ns	
Energy Dissipation During Turn-on Time	$E_{on}$		5.28		mJ	
Energy Dissipation During Turn-off Time	$E_{off}$		2.27		mJ	
SC Data	$I_{SC}$		$t_p \leq 10\mu s, V_{GE}=15V, T_{vj}=150^\circ C,$ $V_{CC}=900V, V_{CEM} \leq 1200V$	140		A

## ● Diode-brake-chopper

### Absolute Maximum Ratings

Parameter	Symbol	Conditions	Value	Unit
Repetitive Peak Reverse Voltage	$V_{RRM}$	$T_{vj}=25^\circ C$	1200	V
Continuous DC Forward Current	$I_F$		15	A
Repetitive Peak Forward Current	$I_{FRM}$	$t_p=1ms$	30	A
$I^2t$ -value	$I^2t$	$V_R=0V, t_p=10ms, T_{vj}=125^\circ C$	16.0	A <sup>2</sup> s
		$V_R=0V, t_p=10ms, T_{vj}=150^\circ C$	14.0	

### Characteristic Values

Parameter	Symbol	Conditions	Value			Unit
			Min.	Typ.	Max.	
Forward Voltage	$V_F$	$I_F=15A, T_{vj}=25^\circ C$		2.00	2.80	V
		$I_F=15A, T_{vj}=125^\circ C$		1.80		
		$I_F=15A, T_{vj}=150^\circ C$		1.75		
Recovered Charge	$Q_{rr}$	$I_F=15A$		0.45		uC
Peak Reverse Recovery Current	$I_{rr}$	$V_R=600V$ $-di_F/dt = 600A/\mu s$		13		A
Reverse Recovery Energy	$E_{rec}$	$T_{vj}=25^\circ C$		0.49		mJ
Recovered Charge	$Q_{rr}$	$I_F=15A$		0.54		uC
Peak Reverse Recovery Current	$I_{rr}$	$V_R=600V$ $-di_F/dt = 600A/\mu s$		14		A
Reverse Recovery Energy	$E_{rec}$	$T_{vj}=150^\circ C$		0.68		mJ



## ● Diode-rectifier

### Absolute Maximum Ratings

Parameter	Symbol	Conditions	Value	Unit
Repetitive Peak Reverse Voltage	$V_{RRM}$	$T_{vj}=25^{\circ}C$	1600	V
Average output Current 50/60Hz, sine wave	$I_{F(AV)}$	$T_C=100^{\circ}C$	35	A
Maximum RMS Current at Rectifier Output	$I_{RMSM}$	$T_C=100^{\circ}C$	60	A
Surge Forward Current	$I_{FSM}$	$V_R=0V, t_p=10ms, T_{vj}=25^{\circ}C$	420	A
		$V_R=0V, t_p=10ms, T_{vj}=150^{\circ}C$	350	A
I <sup>2</sup> t-value	I <sup>2</sup> t	$V_R=0V, t_p=10ms, T_{vj}=25^{\circ}C$	880	A <sup>2</sup> s
		$V_R=0V, t_p=10ms, T_{vj}=150^{\circ}C$	610	A <sup>2</sup> s

### Characteristic Values

Parameter	Symbol	Conditions	Value			Unit
			Min.	Typ.	Max.	
Diode Forward Voltage	$V_F$	$I_F=10A, T_{vj}=150^{\circ}C$		1.02		V
Reverse Current	$I_R$	$T_{vj}=150^{\circ}C, V_R=1600V$			2	mA

## ● NTC-Thermistor

### Characteristic values

Parameter	Symbol	Conditions	Value			Unit
			Min.	Typ.	Max.	
Rated Resistance	$R_{25}$			5.0		kΩ
Deviation of R100	$\Delta R/R$	$T_C=100, R_{100}=493.3\Omega$	-5		5	%
Power Dissipation	$P_{25}$				20.0	mW
B-value	$B_{25/50}$	$R_2=R_{25}\exp[B_{25/50}(1/T_2-1/(298.15 K))]$		3375		K



## ● Module Characteristics

 $T_C=25^{\circ}\text{C}$  unless otherwise specified

Parameter	Symbol	Conditions	Value			Unit
			Min.	Typ.	Max.	
Isolation voltage	$V_{\text{isol}}$	$t=1\text{min}, f=50\text{Hz}$	2500			V
Maximum Junction Temperature	$T_{\text{jmax}}$				175	$^{\circ}\text{C}$
Operating Junction Temperature	$T_{\text{vjop}}$		-40		150	$^{\circ}\text{C}$
Storage Temperature	$T_{\text{stg}}$		-40		125	$^{\circ}\text{C}$
Stray-inductance-module	$L_{\text{SCE}}$			30		nH
Module lead resistance, terminals-chip	$R_{\text{CC}'+\text{EE}'}$	$T_C=25^{\circ}\text{C}$ , per switch		5.00		m $\Omega$
	$R_{\text{AA}'+\text{CC}'}$			6.00		
Thermal Resistance Junction-to Case	$R_{\theta\text{JC}}$	per IGBT-inverter			0.70	K/W
		per Diode-inverter			1.30	
		per IGBT-brake-chopper			0.70	
		per Diode-chopper			1.80	
		per Diode-rectifier			1.35	
Thermal Resistance Case-to Sink	$R_{\theta\text{CS}}$	per IGBT-inverter		0.60		K/W
		per Diode-inverter		0.75		
		per IGBT-brake-chopper		0.60		
		per Diode-chopper		1.05		
		per Diode-rectifier		0.95		
		per Module		0.037		
Mounting Force Per Clamp	F		30		80	N
Weight of Module	G			45		g

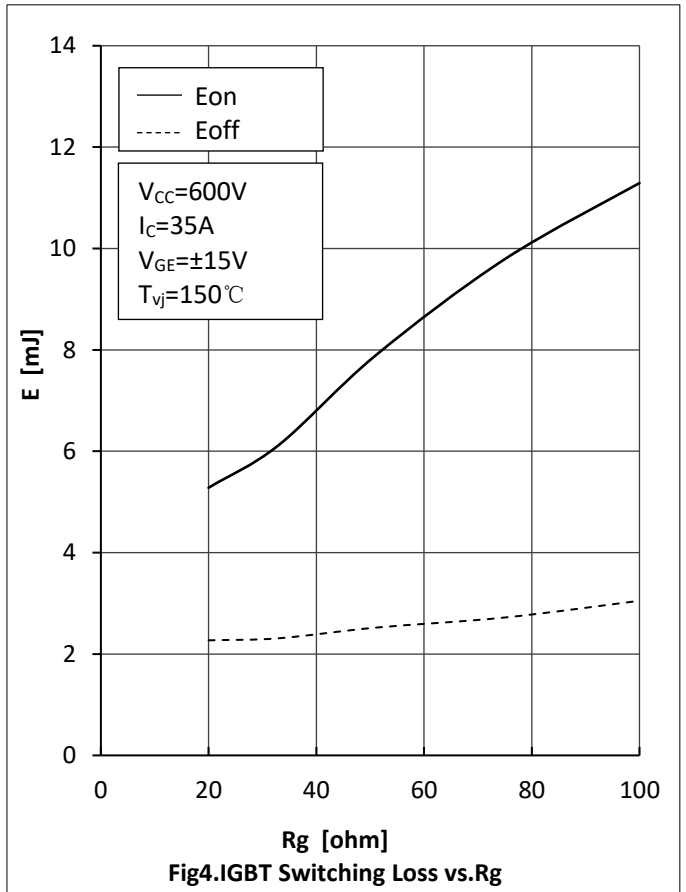
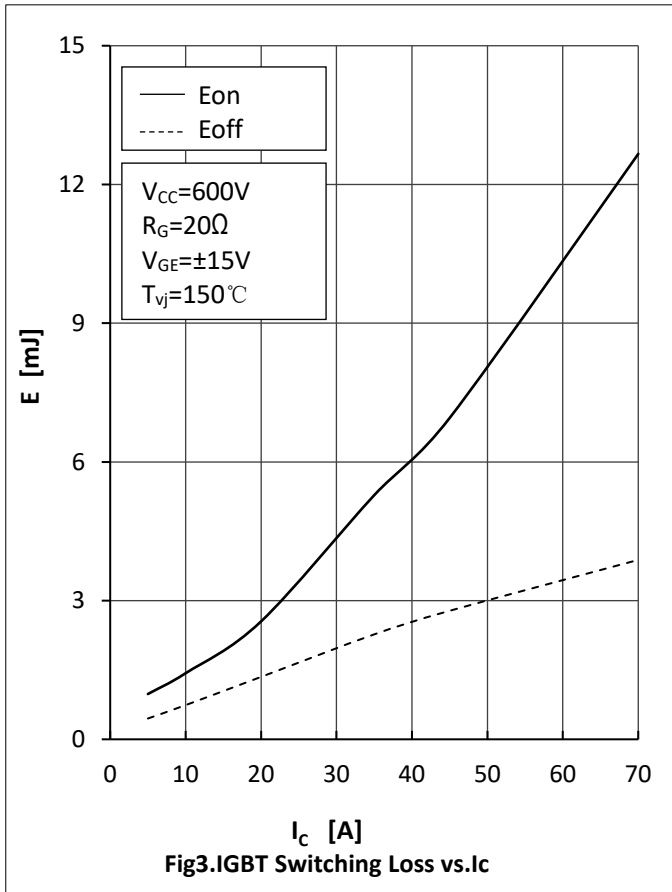
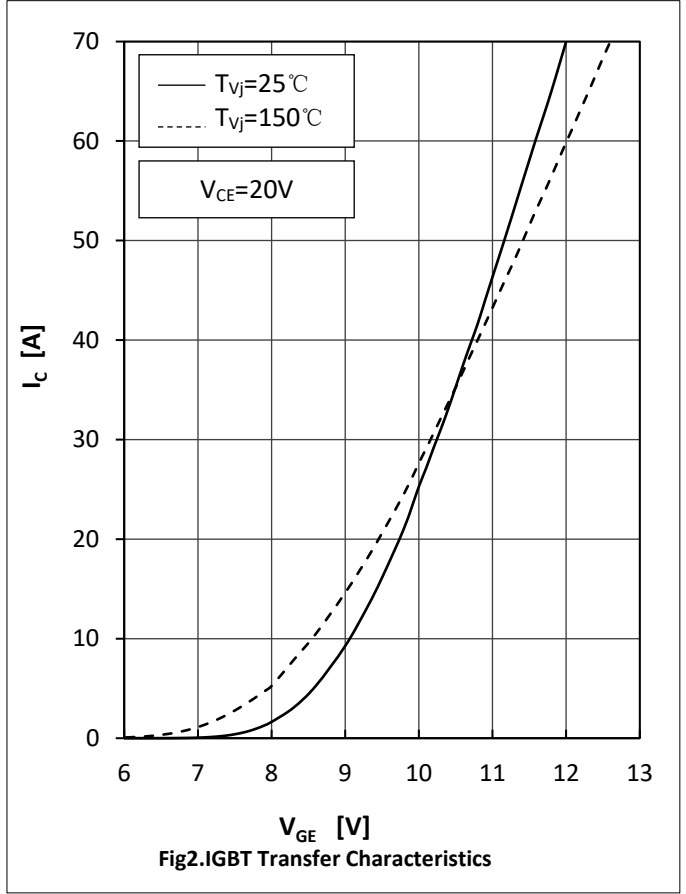
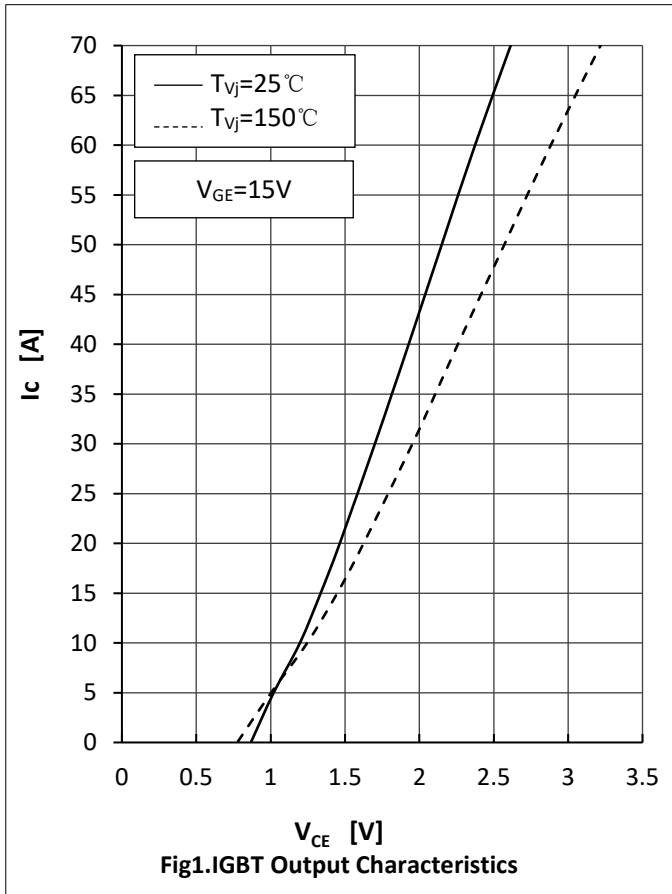



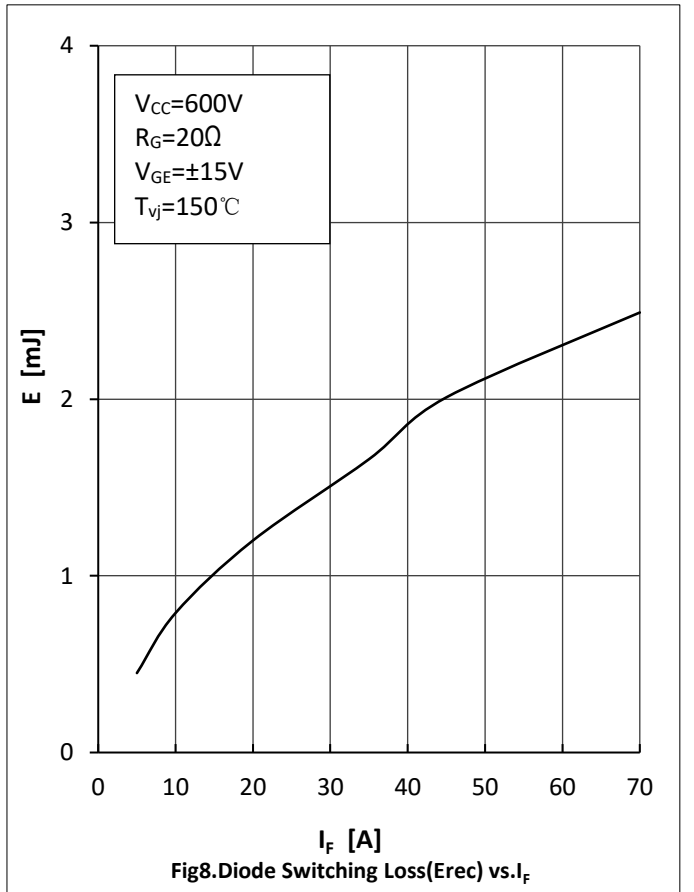
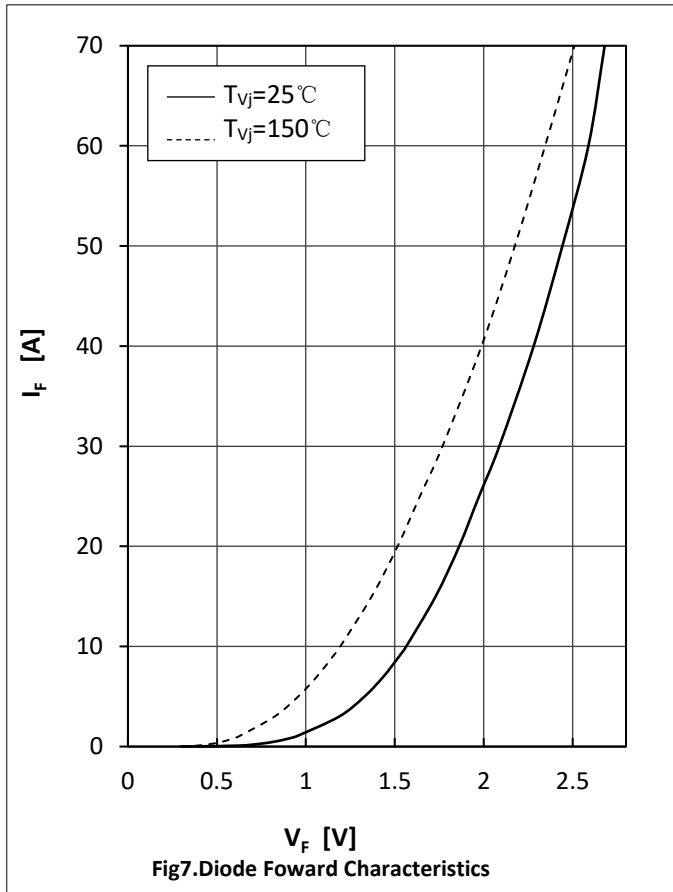
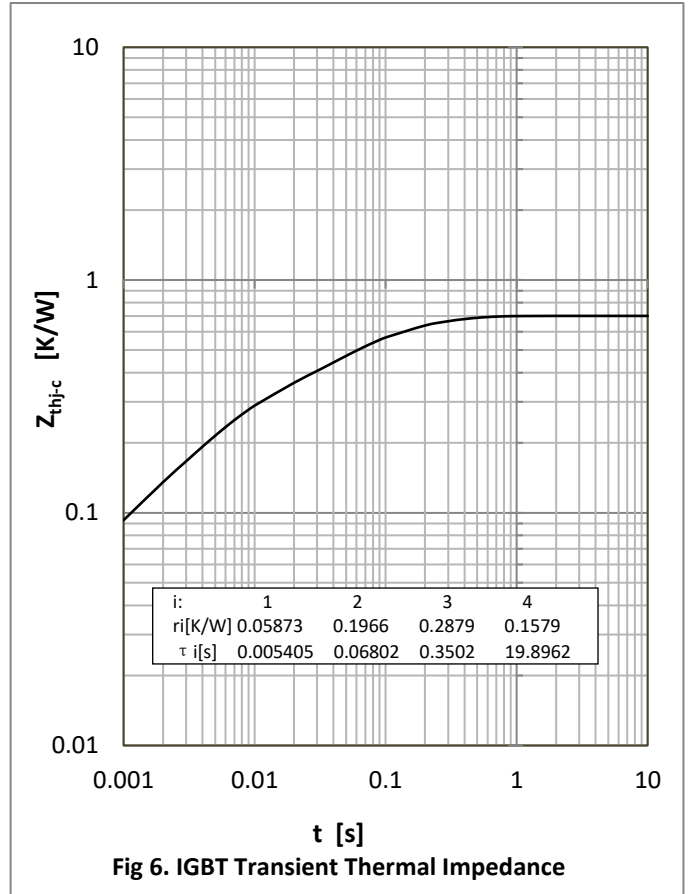
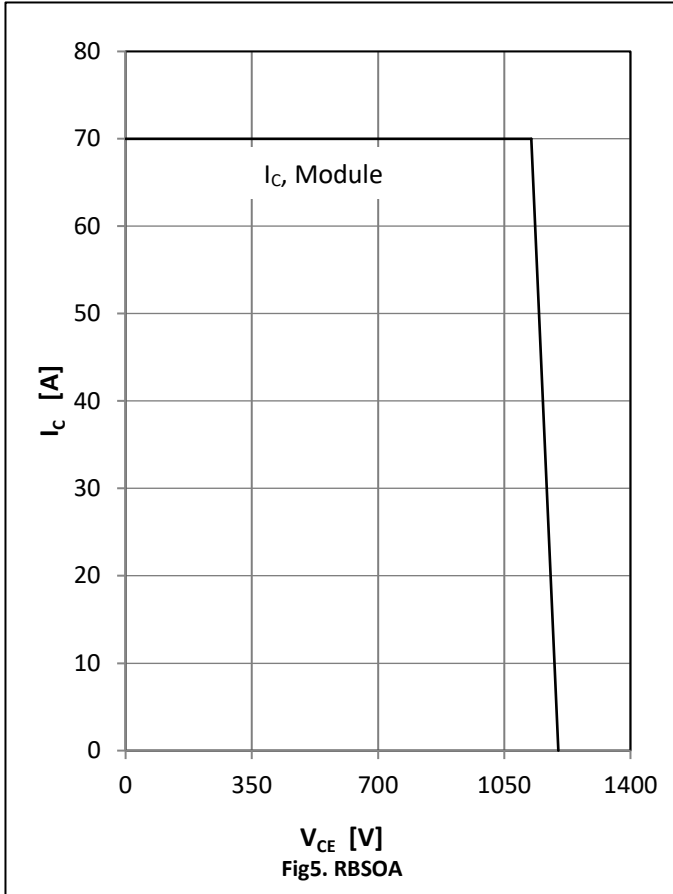

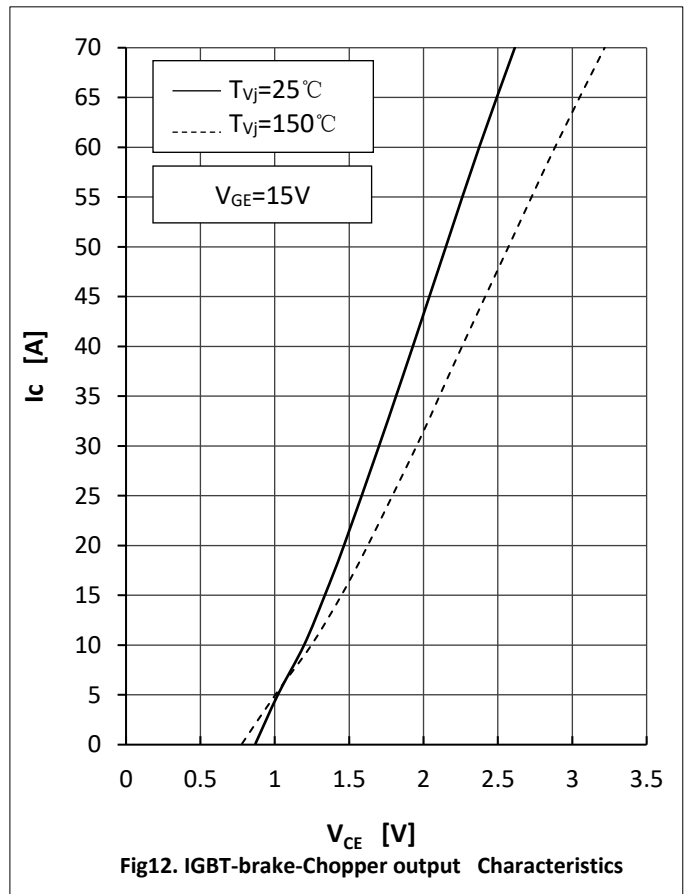
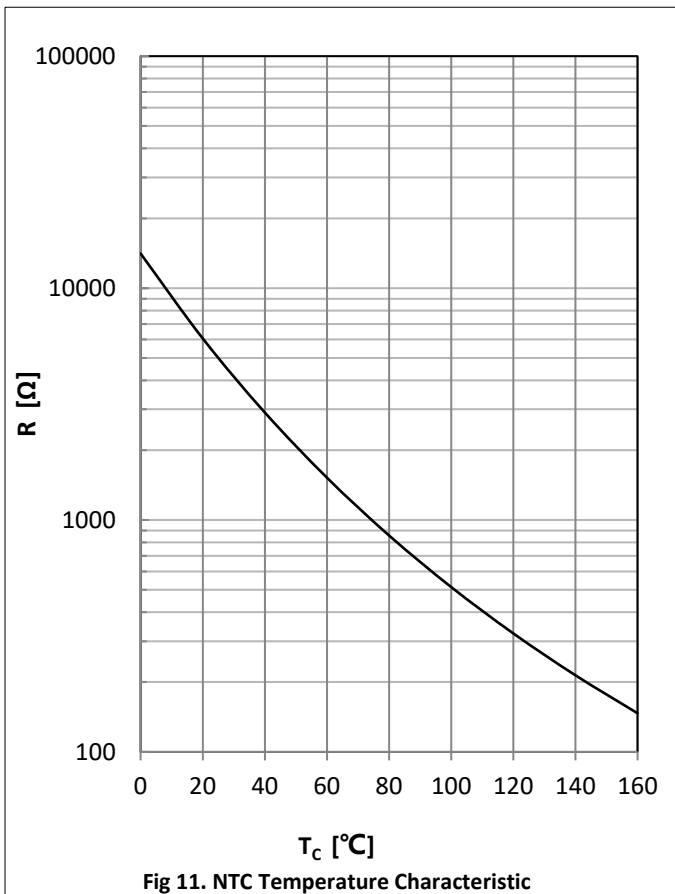
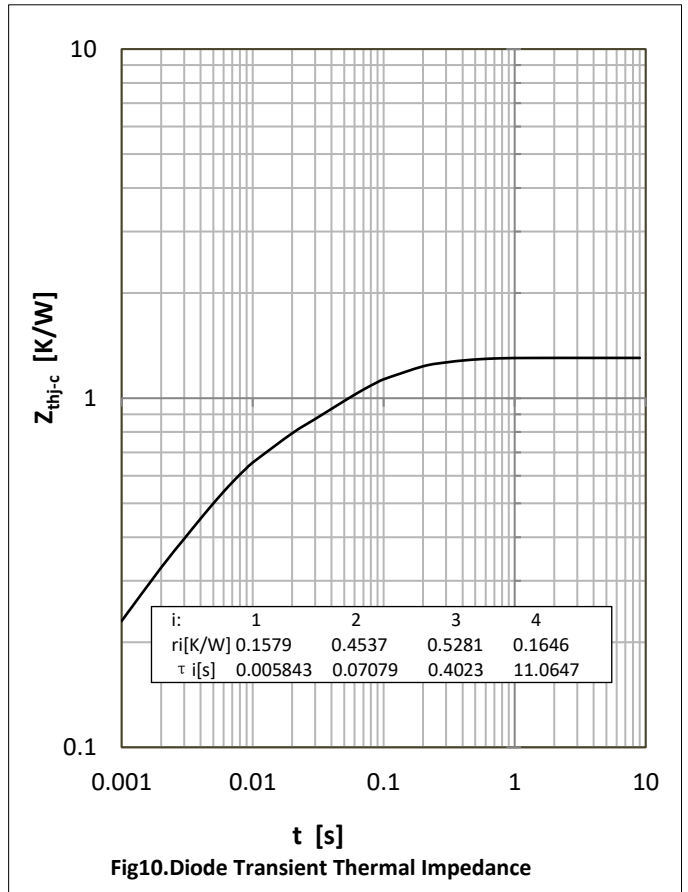
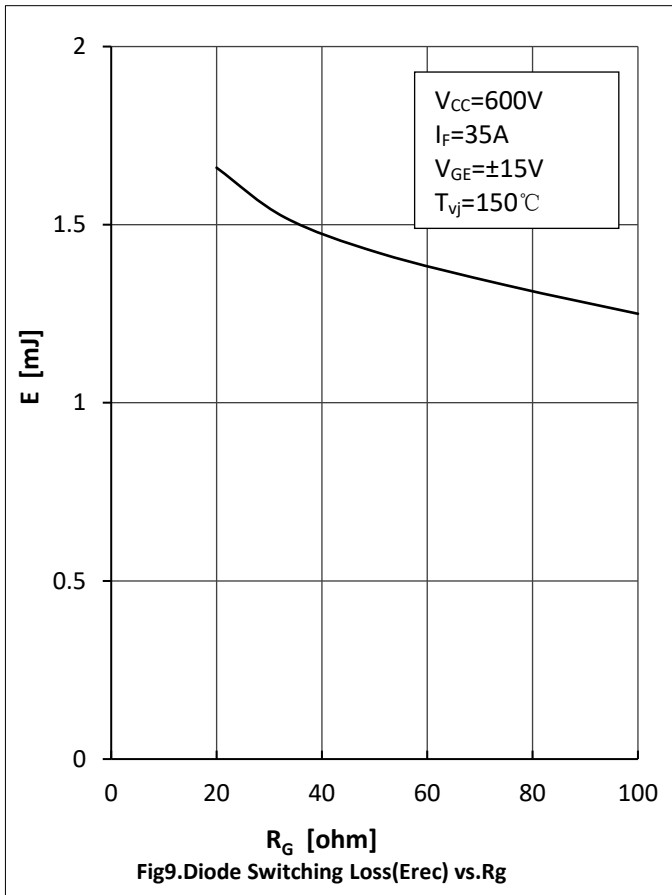

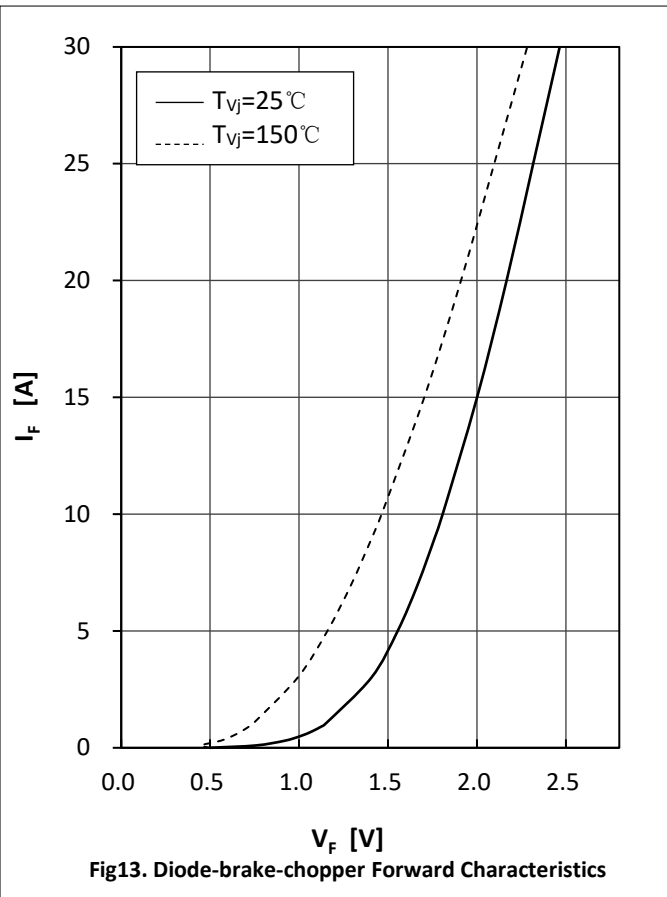



## Circuit Diagram

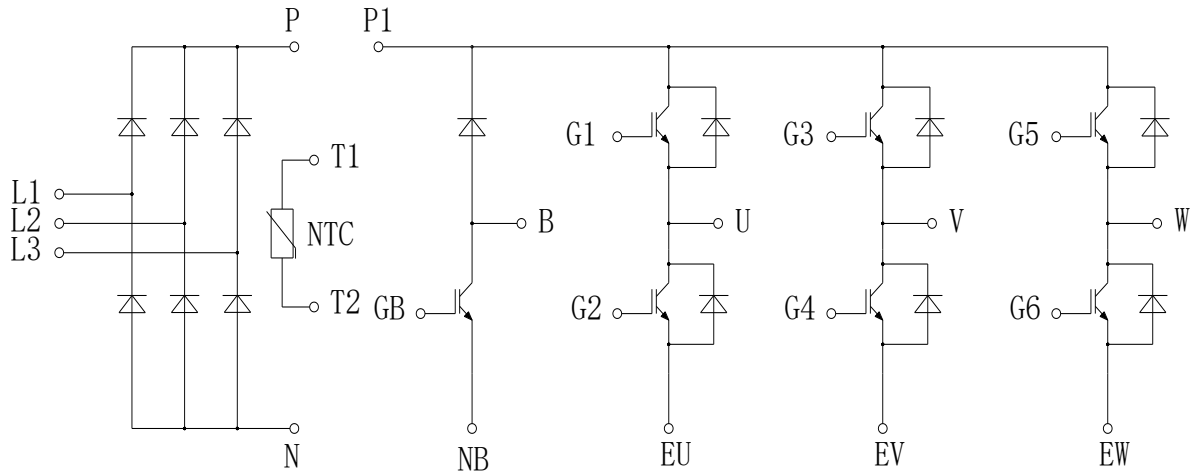

## Package Dimensions

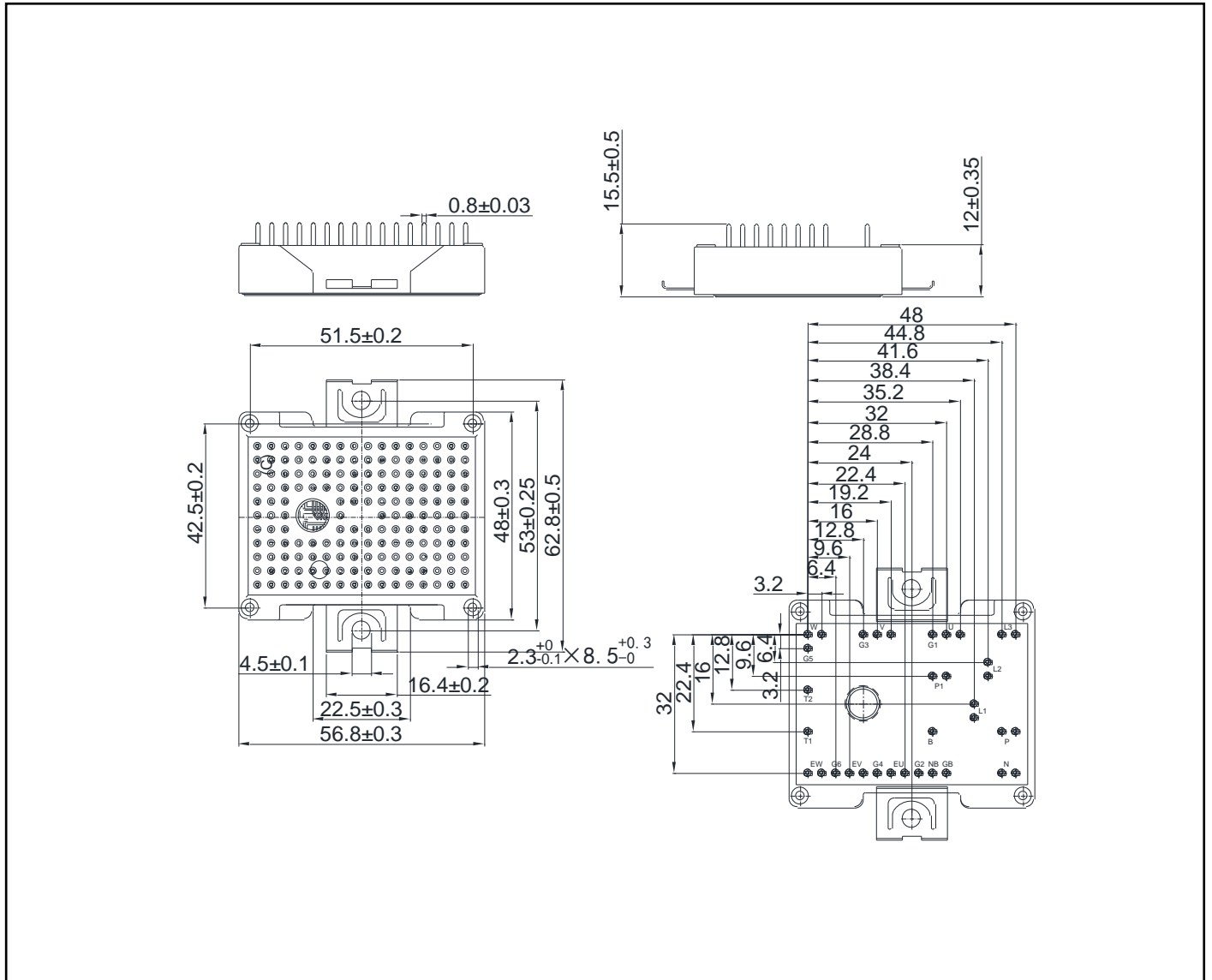



## Disclaimer

The information presented in this document is for reference only. Yangzhou Yangjie Electronic Technology Co., Ltd. reserves the right to make changes without notice for the specification of the products displayed herein to improve reliability, function or design or otherwise.

The product listed herein is designed to be used with ordinary electronic equipment or devices, and not designed to be used with equipment or devices which require high level of reliability and the malfunction of which would directly endanger human life (such as aerospace machinery, nuclear-reactor controllers, fuel controllers and other safety devices), Yangjie or anyone on its behalf, assumes no responsibility or liability for any damages resulting from such improper use of sale.

This publication supersedes & replaces all information previously supplied. For additional information, please visit our website [http:// www.21yangjie.com](http://www.21yangjie.com) , or consult your nearest Yangjie's sales office for further assistance.