

IGBT Modules

V_{CES}	1200V
I_c	600A

Applications

- UPS (Uninterruptible Power Supplies)
- Motion/servo control
- High frequency switching application
- Welding machine

Features

- Low $V_{CE(sat)}$ with Trench technology
- $V_{CE(sat)}$ with positive temperature coefficient
- High short circuit capability(10us)
- Including ultra fast & soft recovery anti-parallel FWD
- Low inductance
- Maximum junction temperature 175°C

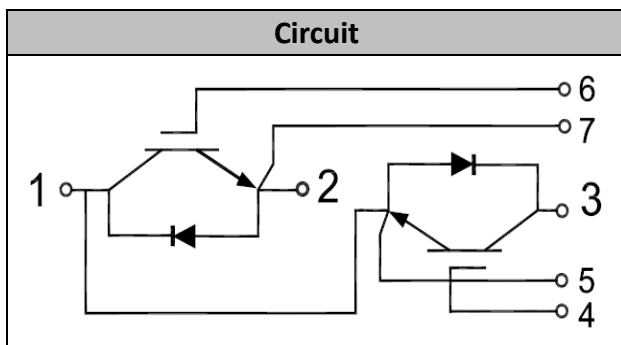

● IGBT

Absolute Maximum Ratings

Parameter	Symbol	Conditions	Value	Unit
Collector-Emitter Voltage	V_{CES}	$V_{GE}=0V, I_c=1mA, T_{vj}=25^{\circ}C$	1200	V
Continuous Collector Current	I_c	$T_C=100^{\circ}C$	600	A
Repetitive Peak Collector Current	I_{CRM}	$t_p=1ms$	1200	A
Gate-Emitter Voltage	V_{GES}	$T_{vj}=25^{\circ}C$	± 20	V
Total Power Dissipation	P_{tot}	$T_C=25^{\circ}C$ $T_{vjmax}=175^{\circ}C$	2580	W



Characteristic Values

Parameter	Symbol	Conditions	Value			Unit	
			Min.	Typ.	Max.		
Gate-Emitter Threshold Voltage	$V_{GE(th)}$	$V_{GE}=V_{CE}, I_C=18mA, T_{vj}=25^{\circ}C$	5.0	5.8	6.5	V	
Collector-Emitter Cut-off Current	I_{CES}	$V_{CE}=1200V, V_{GE}=0V, T_{vj}=25^{\circ}C$			1.0	mA	
Collector-Emitter Saturation Voltage	$V_{CE(sat)}$	$I_C=600A, V_{GE}=15V, T_{vj}=25^{\circ}C$		1.65	2.00	V	
		$I_C=600A, V_{GE}=15V, T_{vj}=125^{\circ}C$		1.90			
		$I_C=600A, V_{GE}=15V, T_{vj}=150^{\circ}C$		2.00			
Gate Charge	Q_G			5.8		uC	
Internal Gate Resistor	R_{Gint}			0.56		Ω	
Input Capacitance	C_{ies}	$V_{CE}=25V, V_{GE}=0V,$ $f=1MHz, T_{vj}=25^{\circ}C$		98.5		nF	
Reverse Transfer Capacitance	C_{res}			0.89		nF	
Gate-Emitter leakage current	I_{GES}	$V_{CE}=0V, V_{GE}=20V, T_{vj}=25^{\circ}C$			400	nA	
Turn-on Delay Time	$t_{d(on)}$	$I_C=600A$ $V_{CE}=600V$ $V_{GE}=\pm 15V$ $R_G=1\Omega$ $T_{vj}=25^{\circ}C$		139		ns	
Rise Time	t_r			56		ns	
Turn-off Delay Time	$t_{d(off)}$			255		ns	
Fall Time	t_f			289		ns	
Energy Dissipation During Turn-on Time	E_{on}			41.1		mJ	
Energy Dissipation During Turn-off Time	E_{off}			38.5		mJ	
Turn-on Delay Time	$t_{d(on)}$		$I_C=600A$ $V_{CE}=600V$ $V_{GE}=\pm 15V$ $R_G=1\Omega$ $T_{vj}=150^{\circ}C$		156		ns
Rise Time	t_r				64		ns
Turn-off Delay Time	$t_{d(off)}$				291		ns
Fall Time	t_f				451		ns
Energy Dissipation During Turn-on Time	E_{on}			68.2		mJ	
Energy Dissipation During Turn-off Time	E_{off}			56.4		mJ	
SC Data	I_{sc}	$t_p \leq 10\mu s, V_{GE}=15V,$ $V_{CEM} \leq 1200V$ $T_{vj}=150^{\circ}C, V_{CC}=600V,$			2400		A



● Diode

Absolute Maximum Ratings

	Symbol	Conditions	Value	Unit
Repetitive Peak Reverse Voltage	V_{RRM}	$T_{vj}=25^{\circ}C$	1200	V
Continuous DC Forward Current	I_F		600	A
Repetitive Peak Forward Current	I_{FRM}	$t_p=1ms$	1200	A
I^2t -value	I^2t	$V_R=0V, t_p=10ms, T_{vj}=125^{\circ}C$	35000	A ² s
		$V_R=0V, t_p=10ms, T_{vj}=150^{\circ}C$	32000	

Characteristic Values

Parameter	Symbol	Conditions	Value			Unit
			Min.	Typ.	Max.	
Forward Voltage	V_F	$I_F=600A, T_{vj}=25^{\circ}C$		1.55	2.10	V
		$I_F=600A, T_{vj}=125^{\circ}C$		1.46		
		$I_F=600A, T_{vj}=150^{\circ}C$		1.41		
Recovered Charge	Q_{rr}	$I_F=600A$		43.1		μC
Peak Reverse Recovery Current	I_{rr}	$V_R=600V$ $-di_F/dt=5000A/\mu s$		365		A
Reverse Recovery Energy	E_{rec}	$T_{vj}=25^{\circ}C$		24.5		mJ
Recovered Charge	Q_{rr}	$I_F=600A$		72.5		μC
Peak Reverse Recovery Current	I_{rr}	$V_R=600V$ $-di_F/dt=5000A/\mu s$		561		A
Reverse Recovery Energy	E_{rec}	$T_{vj}=150^{\circ}C$		42.5		mJ



● Module Characteristics

T_C=25°C unless otherwise specified

Parameter	Symbol	Conditions	Value			Unit
			Min.	Typ.	Max.	
Isolation voltage	V _{isol}	t=1min,f=50Hz	2500			V
Maximum Junction Temperature	T _{jmax}				175	°C
Operating Junction Temperature	T _{vj op}		-40		175	°C
Storage Temperature	T _{stg}		-40		125	°C
Thermal Resistance Junction to Case	R _{eJC}	per IGBT			0.058	K/W
		per Diode			0.075	
Thermal Resistance Case to Sink	R _{eCS}	Conductive grease applied		0.035		K/W
Comparative Tracking Index	CTI		400			
Module Electrodes Torque	M _t	Recommended(M6)	3.0		5.0	N·m
Module to Sink Torque	M _s	Recommended(M6)	3.0		5.0	N·m
Weight of Module	G			315		g

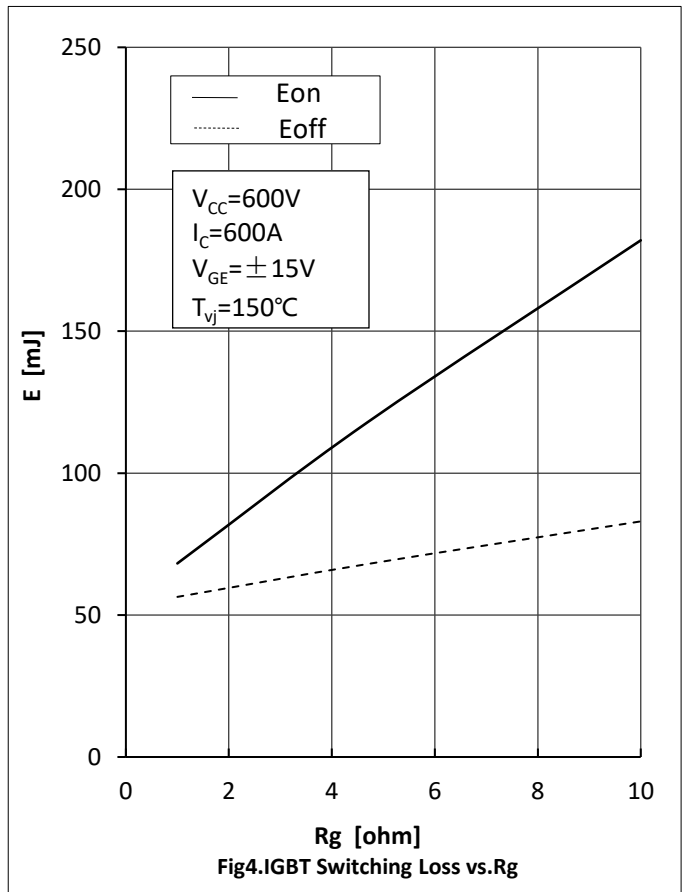
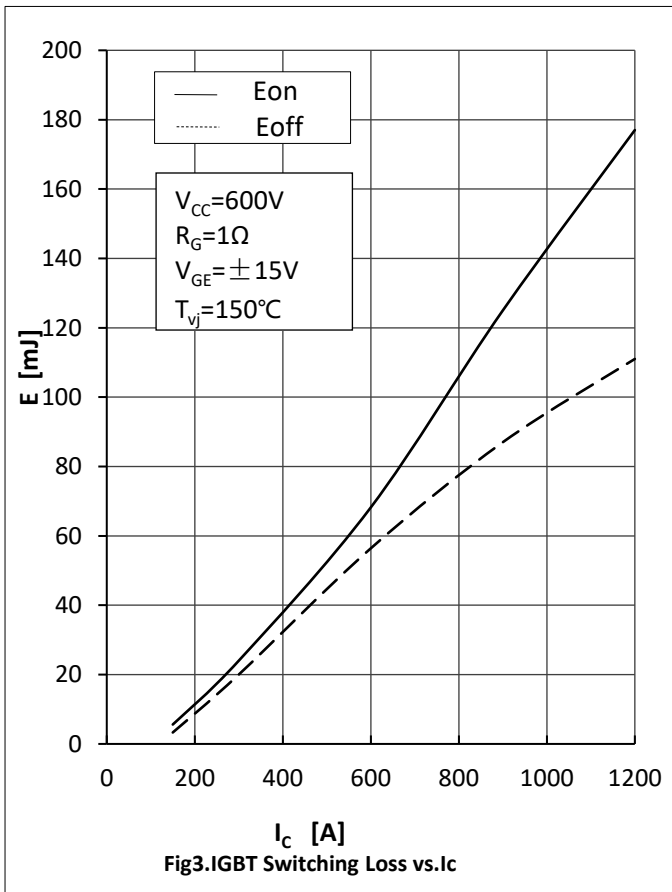
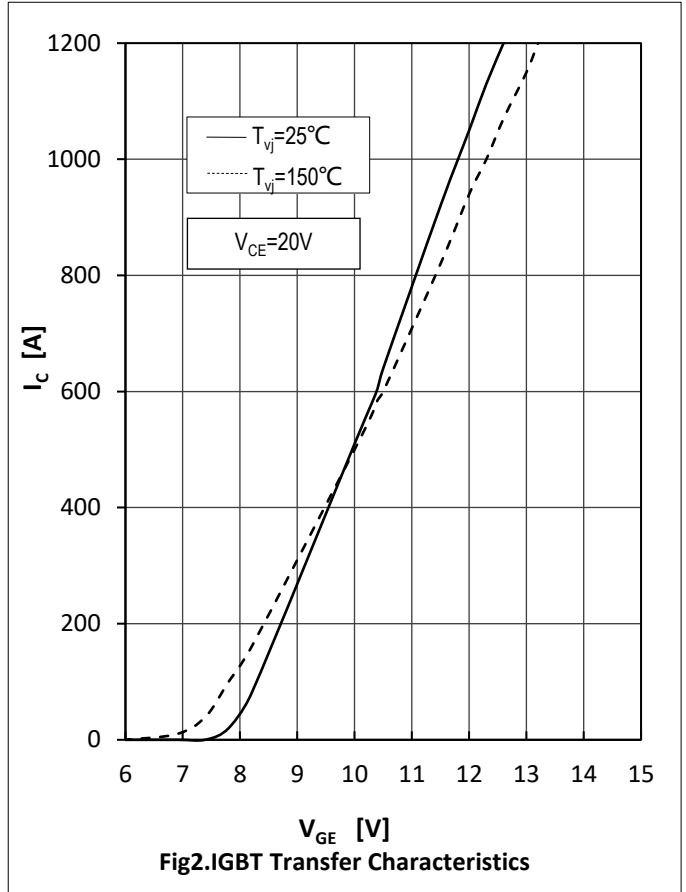
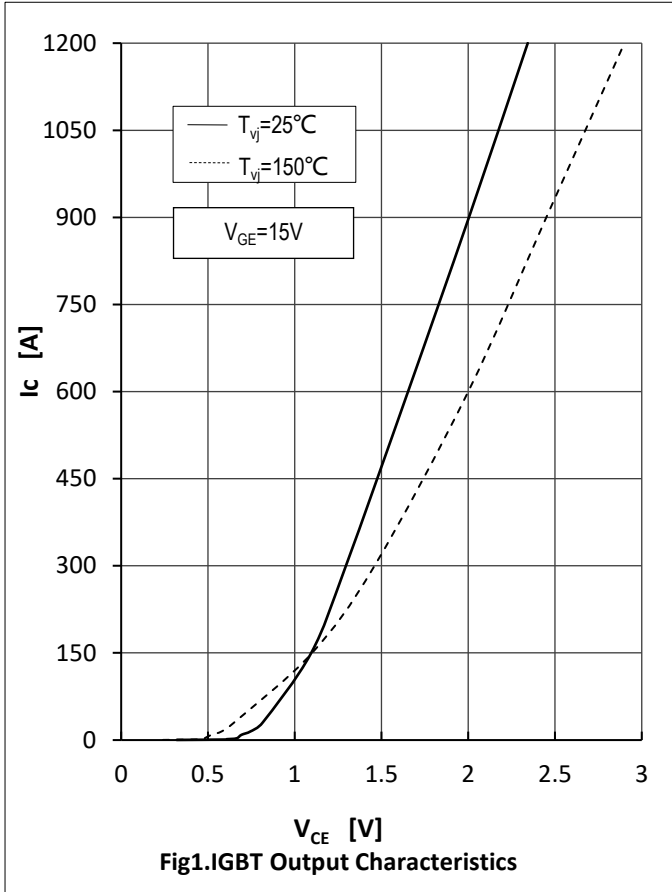

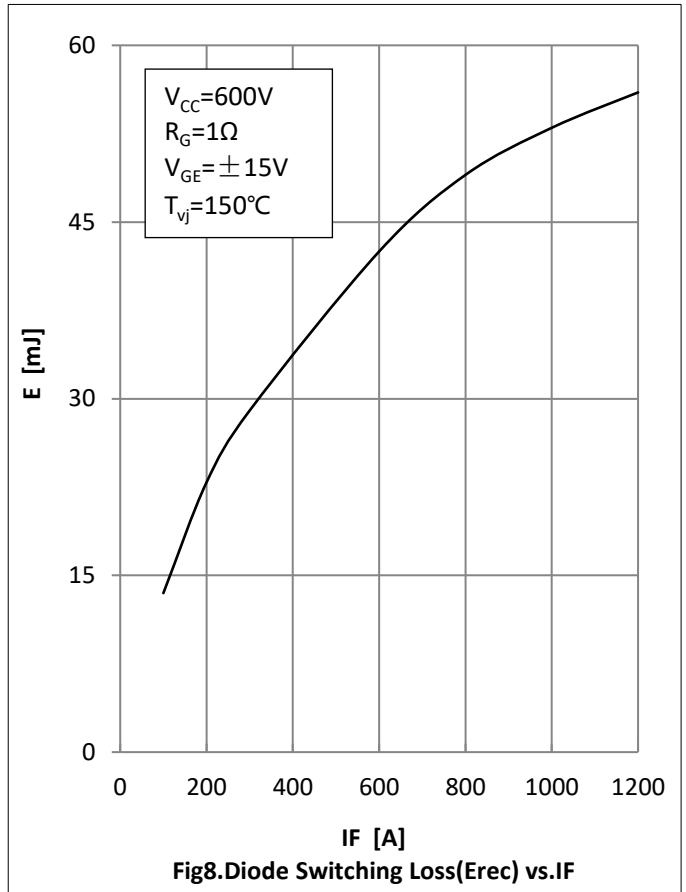
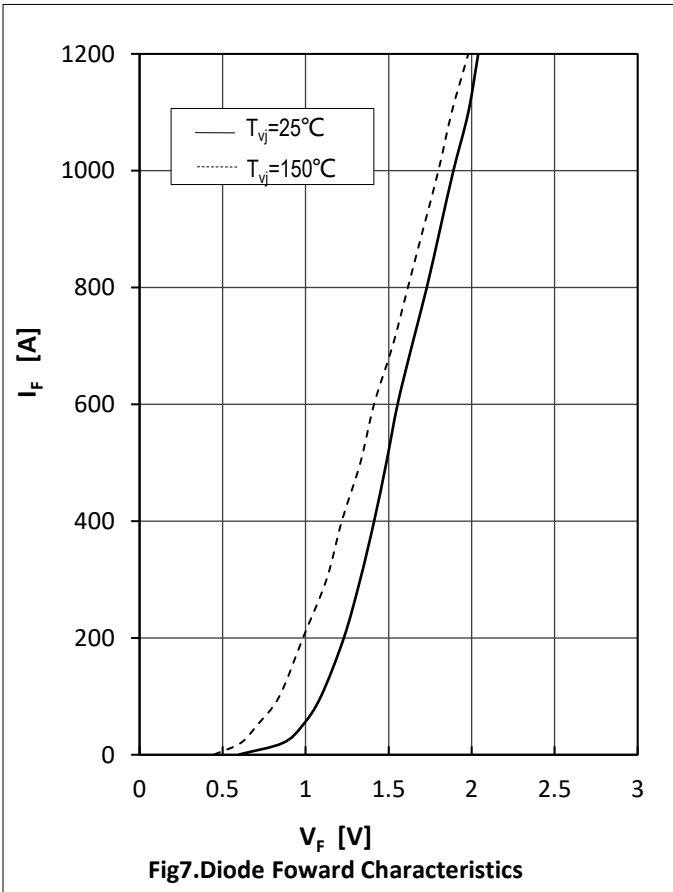
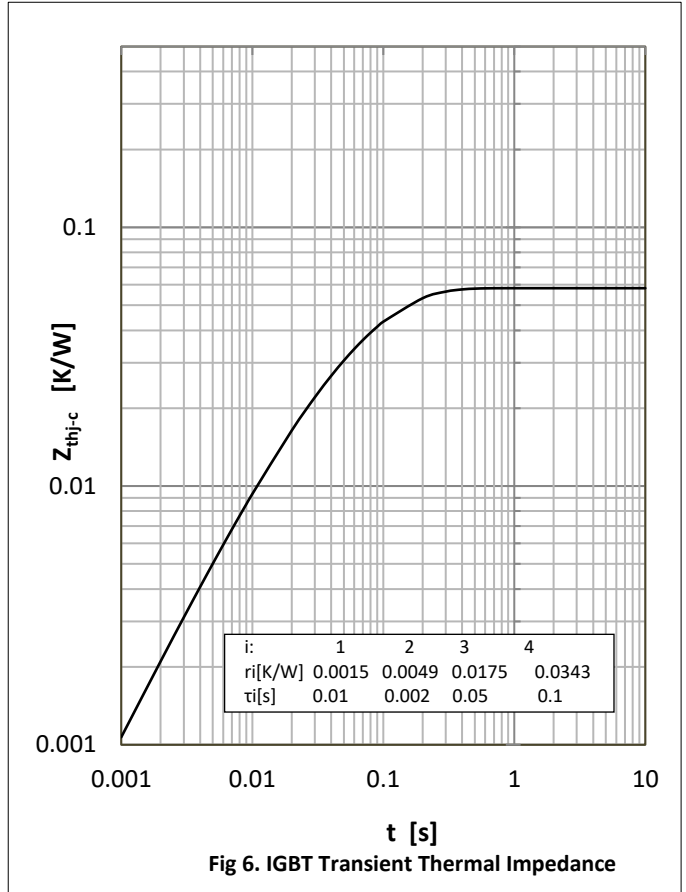
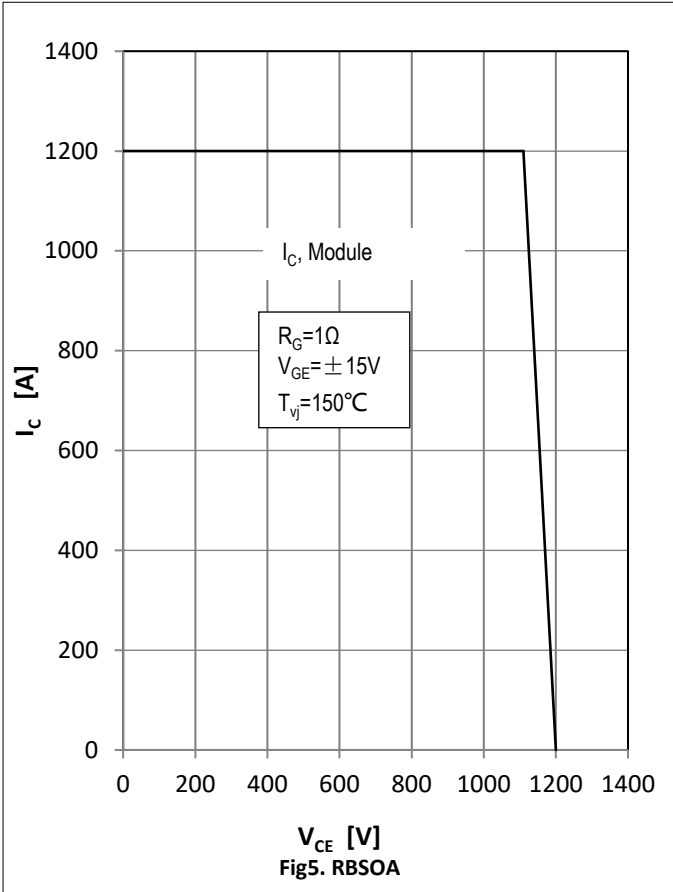

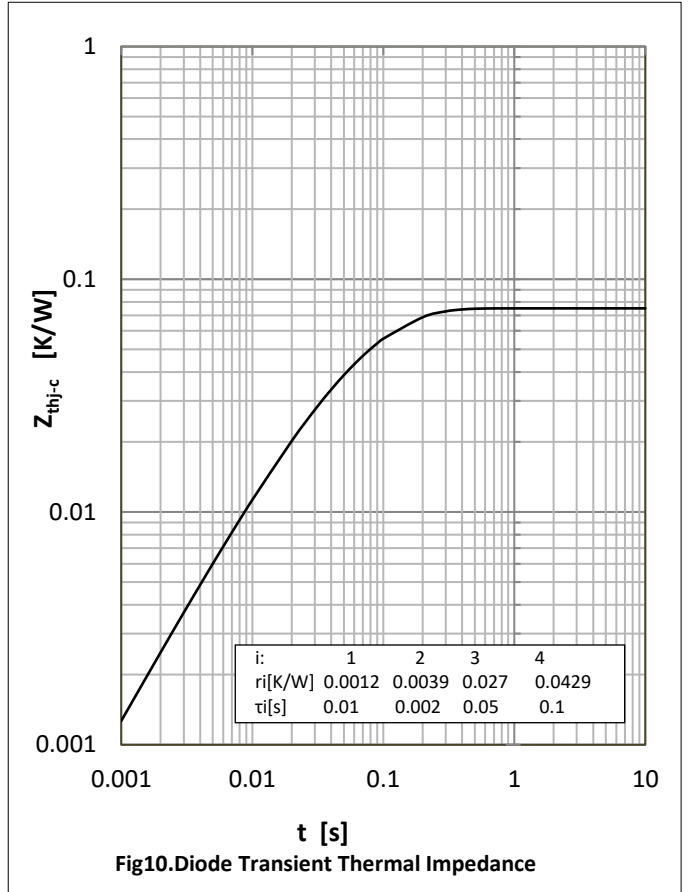
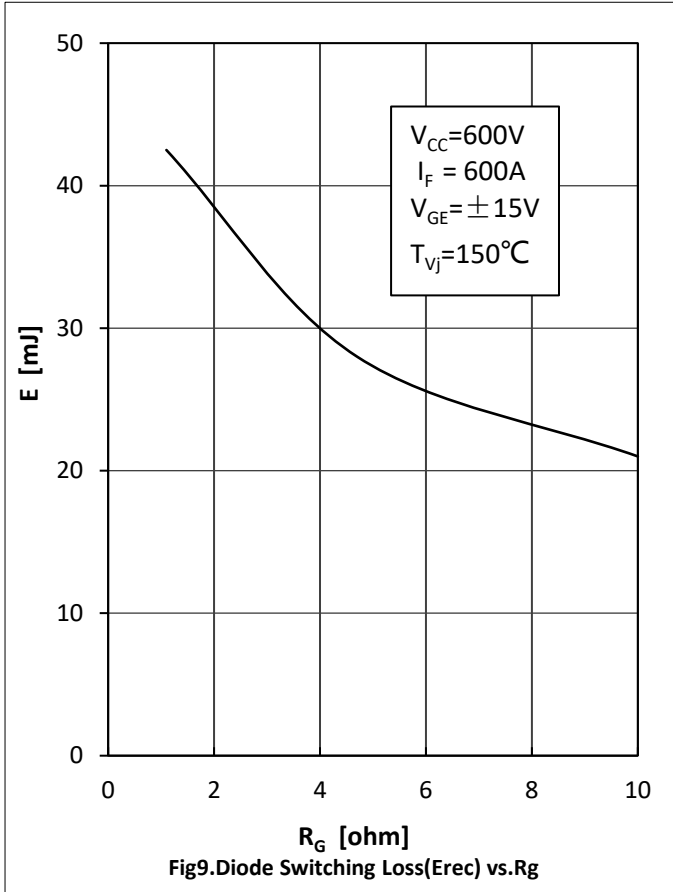



Disclaimer

The information presented in this document is for reference only. Yangzhou Yangjie Electronic Technology Co., Ltd. reserves the right to make changes without notice for the specification of the products displayed herein to improve reliability, function or design or otherwise.

The product listed herein is designed to be used with ordinary electronic equipment or devices, and not designed to be used with equipment or devices which require high level of reliability and the malfunction of which would directly endanger human life (such as aerospace machinery, nuclear-reactor controllers, fuel controllers and other safety devices), Yangjie or anyone on its behalf, assumes no responsibility or liability for any damages resulting from such improper use of sale.

This publication supersedes & replaces all information previously supplied. For additional information, please visit our website [http:// www.21yangjie.com](http://www.21yangjie.com) , or consult your nearest Yangjie's sales office for further assistance.